

# valvole di non ritorno

non-return valves



- Attacchi filettati femmina-femmina e maschio-femmina  
*Threaded ports female-female and male-female*
- Da M5 a G1/4"  
*From M5 to G1/4"*
- A richiesta corpo nichelato  
*Nickel plated valve body on request*
- Guarnizioni in Viton per temperature più elevate  
*Viton seals for higher temperatures*



3

## Materiali

Corpo: ottone OT58

Molla: INOX

Guarnizioni: NBR

Parti interne: ottone OT58

## Materials

Body: brass OT58

Spring: stainless steel

Seals: NBR

Internal parts: brass OT58

Modello <i>Model</i>	VNR 1/8 FF VNR 1/8 MF	VNR 1/4 FF VNR 1/4 MF	VNR M5 FF	VNR 1/8 MFR	VNR 3/8 FF	VNR 1/2 FF
Attacchi <i>Ports</i>	G1/8"	G1/4"	M5	G1/8"	G3/8"	G1/2"
Diametro nominale <i>Nominal orifice</i>	5.2 mm	7 mm	2.2 mm	4 mm	8.5 mm	10 mm
Portata nominale a 6 bar <i>Nominal flow rate at 6 bar</i>	500 NI/min	900 NI/min	100 NI/min	350 NI/min	2000 NI/min	3500 NI/min
Temperatura di esercizio <i>Temperature range</i>	max +60°C VITON: max +110°C					
Pressione di esercizio <i>Working pressure</i>	2 ... 10 bar 0.2 ... 1 MPa					
Fluido <i>Fluid</i>	Aria filtrata 50µ con o senza lubrificazione 50µ filtered, lubricated or non lubricated air					

# valvole di non ritorno

non-return valves



## VNR M5 FF

valvola di non ritorno femmina-femmina M5  
non-return valve female-female M5

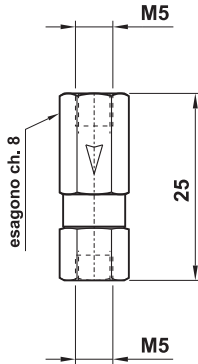

### Versioni disponibili - Available versions

codice - code	descrizione - description
11.010.4	<b>standard:</b> corpo in ottone, guarnizioni in NBR <i>standard: valve body in brass, seals in NBR</i>
11.011.4	corpo in ottone, guarnizioni in NBR, senza molla <i>valve body in brass, seals in NBR, without spring</i>
11.024.4	corpo in ottone nichelato, guarnizioni in NBR <i>valve body in nickel plated brass, seals in NBR</i>
11.046.4	corpo in ottone, guarnizioni in VITON <i>valve body in brass, seals in VITON</i>
11.050.4	corpo in ottone nichelato, guarnizioni in VITON <i>valve body in nickel plated brass, seals in VITON</i>

## VNR 1/8 FF

valvola di non ritorno femmina-femmina 1/8"  
non-return valve female-female 1/8"

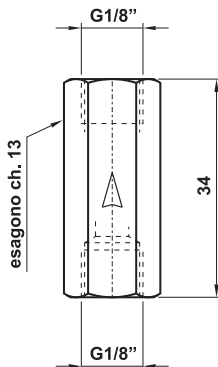

### Versioni disponibili - Available versions

codice - code	descrizione - description
11.000.4	<b>standard:</b> corpo in ottone, guarnizioni in NBR <i>standard: valve body in brass, seals in NBR</i>
11.002.4	corpo in ottone, guarnizioni in VITON <i>valve body in brass, seals in VITON</i>
11.004.4	corpo in ottone nichelato, guarnizioni in NBR <i>valve body in nickel plated brass, seals in NBR</i>
11.009.4	corpo in ottone, guarnizioni in SILICONE <i>valve body in brass, seals in SILICON</i>
11.027.4	corpo in ottone, guarnizioni in NBR, senza molla <i>valve body in brass, seals in NBR, without spring</i>
11.031.4	corpo in ottone nichelato, guarnizioni in VITON <i>valve body in nickel plated brass, seals in VITON</i>
11.035.4	corpo in ottone, guarnizioni in NBR, molla tenera <i>valve body in brass, seals in NBR, light duty spring</i>
11.034.4	corpo in ottone, guarnizioni in VITON, molla tenera <i>valve body in brass, seals in VITON, light duty spring</i>

## VNR 1/8 MF

valvola di non ritorno maschio-femmina 1/8"  
non-return valve male-female 1/8"

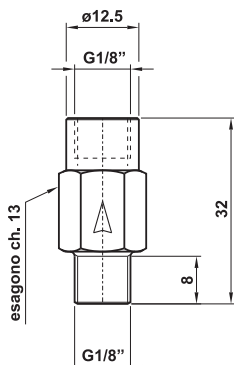

### Versioni disponibili - Available versions

codice - code	descrizione - description
11.006.4	<b>standard:</b> corpo in ottone, guarnizioni in NBR <i>standard: valve body in brass, seals in NBR</i>
11.007.4	corpo in ottone, guarnizioni in VITON <i>valve body in brass, seals in VITON</i>
11.042.4	corpo in ottone, guarnizioni in NBR, molla dura <i>valve body in brass, seals in NBR, heavy duty spring</i>
11.055.4	corpo in ottone nichelato, guarnizioni in NBR <i>valve body in nickel plated brass, seals in NBR</i>
11.045.4	corpo in ottone nichelato, guarnizioni in VITON <i>valve body in nickel plated brass, seals in VITON</i>

# valvole di non ritorno

non-return valves



## VNR 1/8 MFR

valvola di non ritorno maschio-femmina 1/8" rovesciata  
non-return valve female-male 1/8"

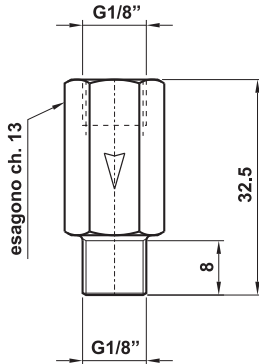

### Versioni disponibili - Available versions

codice - code	descrizione - description
11.008.4	<b>standard:</b> corpo in ottone, guarnizioni in NBR <i>standard: valve body in brass, seals in NBR</i>
11.032.4	corpo in ottone, guarnizioni in VITON <i>valve body in brass, seals in VITON</i>
11.049.4	corpo in ottone nichelato, guarnizioni in NBR <i>valve body in nickel plated brass, seals in NBR</i>
11.056.4	corpo in ottone nichelato, guarnizioni in VITON <i>valve body in nickel plated brass, seals in VITON</i>

## VNR 1/4 FF

valvola di non ritorno femmina-femmina 1/4"  
non-return valve female-female 1/4"

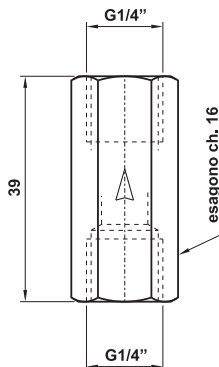

### Versioni disponibili - Available versions

codice - code	descrizione - description
11.001.4	<b>standard:</b> corpo in ottone, guarnizioni in NBR <i>standard: valve body in brass, seals in NBR</i>
11.003.4	corpo in ottone, guarnizioni in VITON <i>valve body in brass, seals in VITON</i>
11.005.4	corpo in ottone nichelato, guarnizioni in NBR <i>valve body in nickel plated brass, seals in NBR</i>
11.030.4	corpo in ottone nichelato, guarnizioni in VITON <i>valve body in nickel plated brass, seals in VITON</i>
11.028.4	corpo in ottone, guarnizioni in NBR, senza molla <i>valve body in brass, seals in NBR, without spring</i>
11.037.4	corpo in ottone, guarnizioni in VITON, senza molla <i>valve body in brass, seals in VITON, without spring</i>
11.036.4	corpo in ottone, guarnizioni in NBR, molla tenera <i>valve body in brass, seals in NBR, light duty spring</i>
11.033.4	corpo in ottone, guarnizioni in VITON, molla tenera <i>valve body in brass, seals in VITON, light duty spring</i>
11.040.4	corpo in ottone, guarnizioni in VITON, molla dura <i>valve body in brass, seals in VITON, heavy duty spring</i>

## VNR 1/4 MF

valvola di non ritorno maschio-femmina 1/4"  
non-return valve male-female 1/4"

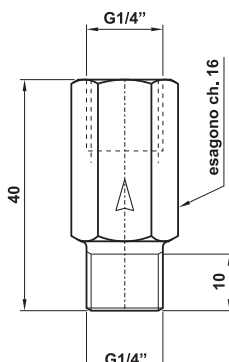

### Versioni disponibili - Available versions

codice - code	descrizione - description
11.047.4	<b>standard:</b> corpo in ottone, guarnizioni in NBR <i>standard: valve body in brass, seals in NBR</i>
11.048.4	corpo in ottone nichelato, guarnizioni in NBR <i>valve body in nickel plated brass, seals in NBR</i>
11.059.4	corpo in ottone nichelato, guarnizioni in VITON <i>valve body in nickel plated brass, seals in VITON</i>

# valvole di non ritorno

non-return valves



## VNR 3/8 FF

valvola di non ritorno femmina-femmina 3/8"

non-return valve female-female 3/8"



### Versioni disponibili - Available versions

codice - code	descrizione - description
11.053.4	<b>standard:</b> corpo in ottone nichelato, guarnizioni in NBR <b>standard:</b> valve body in nickel plated brass, seals in NBR

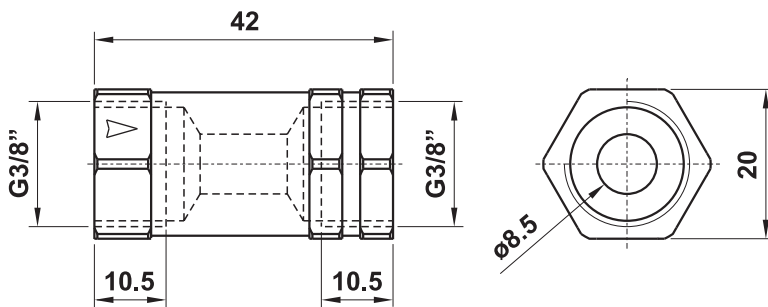

## VNR 1/2 FF

valvola di non ritorno femmina-femmina 1/2"

non-return valve female-female 1/2"



### Versioni disponibili - Available versions

codice - code	descrizione - description
11.103.4	<b>standard:</b> corpo in ottone nichelato, guarnizioni in NBR <b>standard:</b> valve body in nickel plated brass, seals in NBR

