



Mounting flange

BF 30

- Retainer for all cylindrical sensors with M30 thread
- Simple installation and exact setting
- Large sensing range (max. 18 mm)

Mounting flange, 30 mm

Dimensions

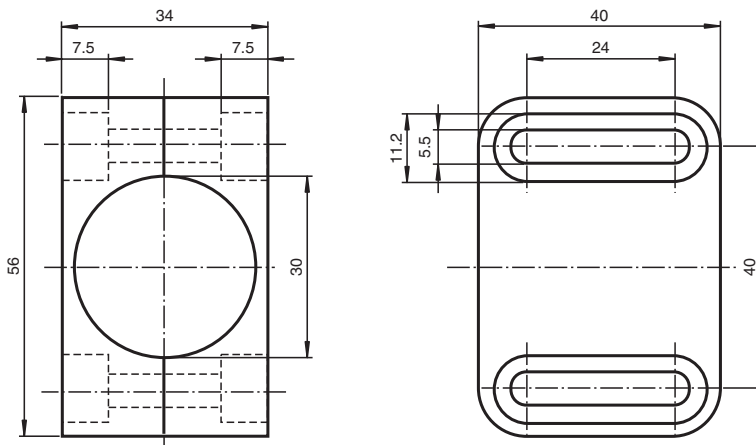

Technical Data

General specifications

Inside diameter 30 mm

Ambient conditions

Ambient temperature -25 ... 85 °C (-13 ... 185 °F)

Mechanical specifications

Material Base: Crastin/PBT (green)
Upper section: PA (transparent)

Tightening torque, fastening screws max. 1.2 Nm

Dimensions

Height 34 mm

Width 56 mm

Length 40 mm