

Cable connector, NAMUR

V1-W-N-15M-PUR

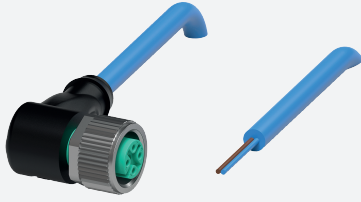

- Suitable for NAMUR technology
- Degree of protection IP68 / IP69
- Suitable for routing intrinsically safe circuits in accordance with DIN EN 60079-14:2014
- Specific design protects against loosening and inaccurate installation

Female cordset single-ended M12 angled A-coded, 2-pin, PUR cable blue, NAMUR



Dimensions

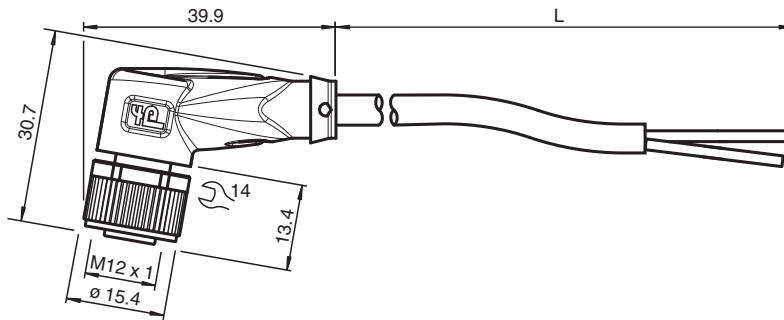

Technical Data

General specifications

Connector 1	
Connection	socket
Construction type	M12
Style	angled
Locking	screw connection
Number of pins	2
Coding	A-coded
Connector 2	
Connection	cable end

Electrical specifications

Operating voltage	U_B	max. 250 V AC/DC
Operating current	I_B	4 A
Resistance per unit length	R'	max. 0.057 Ω/m
Capacitance per unit length	C'	102.4 nF/km
Inductance per unit length	L'	0.49 mH/km

Conformity

Degree of protection	EN 60529
Plug connection	connector M12 x 1 : IEC 61076-2-101

Ambient conditions

Ambient temperature	
---------------------	--

Release date: 2023-08-23 Date of issue: 2023-08-23 Filename: 038250_eng.pdf



Technical Data

Plug connector		-40 ... 90 °C (-40 ... 194 °F)
Cable, fixed		-40 ... 80 °C (-40 ... 176 °F)
Cable, flexing		-20 ... 80 °C (-4 ... 176 °F)
Pollution degree		3
Mechanical specifications		
Plug connector		
Tightening torque		0.6 Nm
Loosening protection		available
Tool installation		straight knurling and hexagon nut SW = 14 mm
Mating cycles		min. 100
Degree of protection		IP68 / IP69
Cable		according to IEC/EN 60228 (DIN VDE 0295) class 6
Sheath diameter		4.8 mm
Bending radius		> 15 x cable diameter, moving > 10 x cable diameter, fixed
Sheath color		blue (similar to RAL 5015)
Number of cores		2
Core cross section		0.34 mm ²
Cores color		Core 1: brown Core 2: blue
Core construction		42 x 0.1 mm Ø
Length	L	15 m
Cable code		Li FY 11Y 2 x 0.34
Material		
Plug connector		
Screw connection		Zinc diecast, nickel-plated
Body		TPU, black
Seal		FKM
Contact surface		gold plated (Au)
Flammability		V-2
Cable		
Sheathing		PUR based on polyether
Core insulation		PVC
Flammability		HB

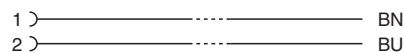



Connection



Accessories

	MH V1-SCREWDRIVER	Torque screwdriver (0.6 Nm)
	MH V1-BIT M12	plug-in cap M12

Accessories

	V1/V3-LABELHOLDER	Label holder
	V1/V3-LABEL	Label plate
	MH V1-Holder	Modular universal holder for M12 connectors
	V1-CLIP	Unlocking protector for M12 connector
	V1-MARKING-RING-COLOR	Marking rings for M12 connectors, various colors