



Current/Voltage Converter

KFD0-CC-Ex1

- 1-channel isolated barrier
- 24 V DC supply (loop powered)
- Current or voltage input
- Output: 4 ... 20 mA
- Potentiometer or DIP switch selectable ranges
- Line fault detection (LFD)



Function

This isolated barrier is used for intrinsic safety applications. It converts a 2-wire voltage or current in the hazardous area to a 4 mA ... 20 mA signal in the safe area.

The device can be used to double signals in 20 mA measurement circuits due to the limited current signal input load of 50 Ω.

DIP switches and potentiometers make field calibration easy.

Since this isolator is loop-powered, use the technical data to verify that the proper voltage is available to the field devices.

Connection

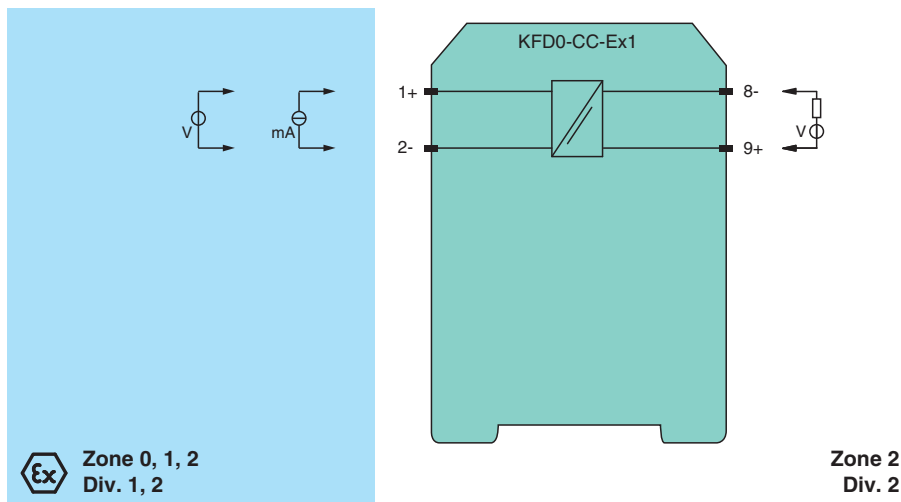

Technical Data

General specifications	
Signal type	Analog input
Supply	
Rated voltage	U_r 12 ... 35 V DC loop powered
Power dissipation	0.4 W
Input	
Connection side	field side
Connection	terminals 1+, 2-
Current range	0 ... 20 mA, load \leq 50 Ω
Voltage range	0 ... 10 V, load \geq 100 kΩ
Output	

Release date: 2022-12-07 Date of issue: 2022-12-07 Filename: 043690_eng.pdf

Technical Data

Connection side	control side
Connection	terminals 9+, 8-
Load	(U -12 V) / 0.02 A
Current output	4 ... 20 mA , limited to ≤ 35 mA
Fault signal	downscaling ≤ 3 mA
Transfer characteristics	
Deviation	
After calibration	0.1 % of full-scale value
Temperature effect	span: 0.050 % of span /K ; zero point: 0.060 % of span /K
Linearization	≤ 0.04 % of full-scale value
Influence of supply voltage	6.5 ppm/V
Rise time	250 ms
Galvanic isolation	
Input/Output	safe isolation according to EN 50178, rated insulation voltage 253 V _{eff}
Indicators/settings	
Control elements	DIP switch potentiometer
Configuration	via DIP switches via potentiometer
Labeling	space for labeling at the front
Directive conformity	
Electromagnetic compatibility	
Directive 2014/30/EU	EN 61326-1:2013 (industrial locations)
Conformity	
Galvanic isolation	EN 50178:1997
Degree of protection	IEC 60529:2001
Ambient conditions	
Ambient temperature	-20 ... 60 °C (-4 ... 140 °F)
Mechanical specifications	
Degree of protection	IP20
Connection	screw terminals
Mass	approx. 100 g
Dimensions	20 x 119 x 115 mm (0.8 x 4.7 x 4.5 inch) (W x H x D) , housing type B2
Mounting	on 35 mm DIN mounting rail acc. to EN 60715:2001
Data for application in connection with hazardous areas	
EU-type examination certificate	ZELM 00 ATEX 0034
Marking	⊕ II (1)GD [EEx ia] IIC
Input	EEx ia IIC
Voltage	U _o 9.6 V
Current	I _o 0.5 mA
Power	P _o 1.1 mW linear characteristic
Output	
Maximum safe voltage	U _m 60 V (Attention! The rated voltage can be lower.)
Certificate	TÜV 01 ATEX 1777 X
Marking	⊕ II 3G Ex nA II T4
Galvanic isolation	
Input/Output	safe electrical isolation acc. to IEC/EN 60079-11, voltage peak value 375 V
Directive conformity	
Directive 2014/34/EU	EN 60079-0:2012+A11:2013 , EN 60079-11:2012 , EN 60079-15:2010
International approvals	
CSA approval	
Control drawing	116-0132
General information	

Technical Data

Supplementary information

Observe the certificates, declarations of conformity, instruction manuals, and manuals where applicable. For information see www.pepperl-fuchs.com.

Assembly

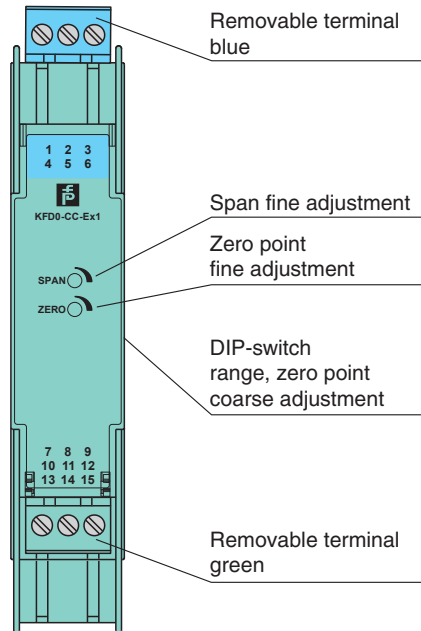

Front view



Matching System Components

	K-DUCT-BU	Profile rail, wiring comb field side, blue
---	------------------	--

Accessories

	KF-ST-5GN	Terminal block for KF modules, 3-pin screw terminal, green
	KF-ST-5BU	Terminal block for KF modules, 3-pin screw terminal, blue
	KF-CP	Red coding pins, packaging unit: 20 x 6

Release date: 2022-12-07 Date of issue: 2022-12-07 Filename: 043690_eng.pdf

Configuration

The device is delivered with the input signal set of 4 mA ... 20 mA.

Example

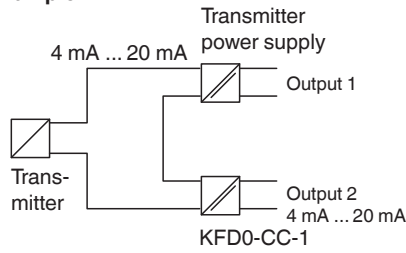

DIP switches function

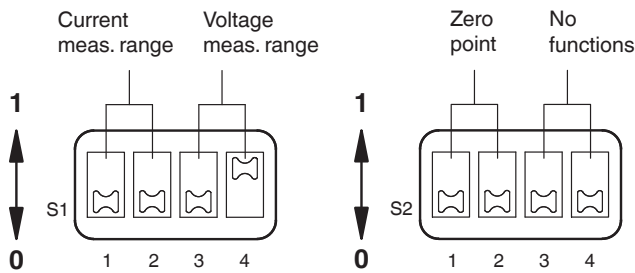

Measurement range	Switch S1 (range)				Switch S2 (zero point)			
	S1.1	S1.2	S1.3	S1.4	S2.1	S2.2	S2.3	S2.4
0 mA ... 20 mA	1	1	-	-	-	-	-	-
4 mA ... 20 mA	1	1	-	-	1	1	-	-
0 V ... 5 V	-	-	1	-	-	-	-	-
1 V ... 5 V	-	-	1	-	1	1	-	-
0 V ... 10 V	-	-	-	1	-	-	-	-
2 V ... 10 V	-	-	-	1	1	1	-	-

Adjustment instruction (example):

Input signal 0 mA ... 20 mA
 Output signal 4 mA ... 20 mA

1. Set DIP switches S1.1 and S1.2 to the position 1. Set all other DIP switches to the position 0.
2. Set input to minimum value of 0 mA.
3. Adjust output, minimum zero point (4 mA).
4. Add maximum value of 20 mA.
5. Adjust output, range maximum value (20 mA)

Repeat steps 2. ... 5., until stable.

Release date: 2022-12-07 Date of issue: 2022-12-07 Filename: 043690_eng.pdf