



# Zener Barrier Z813

- 1-channel
- DC version, negative polarity
- Working voltage 13.7 V at 10  $\mu$ A
- Series resistance max. 29  $\Omega$
- Fuse rating 160 mA
- DIN rail mountable



## Function

The Zener Barrier prevents the transfer of unacceptably high energy from the safe area into the hazardous area. The zener diodes in the Zener Barrier are connected in the reverse direction. The breakdown voltage of the diodes is not exceeded in normal operation. If this voltage is exceeded, due to a fault in the safe area, the diodes start to conduct, causing the fuse to blow. The Zener Barrier has a negative polarity, i. e. the cathodes of the zener diodes are grounded.

## Connection

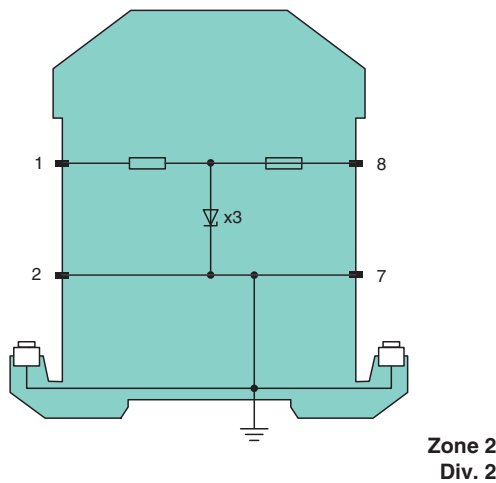
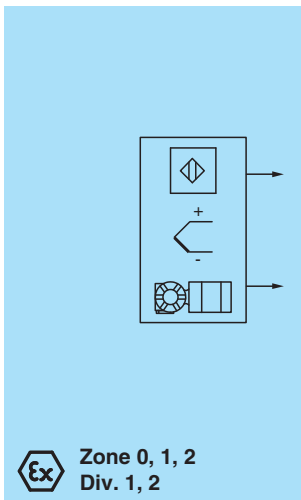

## Technical Data

General specifications	
Type	DC version, negative polarity
Electrical specifications	
Nominal resistance	22 $\Omega$
Series resistance	max. 29 $\Omega$
Fuse rating	160 mA
Hazardous area connection	
Connection	terminals 1, 2
Safe area connection	
Connection	terminals 7, 8
Working voltage	
Supply loop	max. 14.2 V

Release date: 2023-04-06 Date of issue: 2023-04-06 Filename: 071897\_eng.pdf

## Technical Data







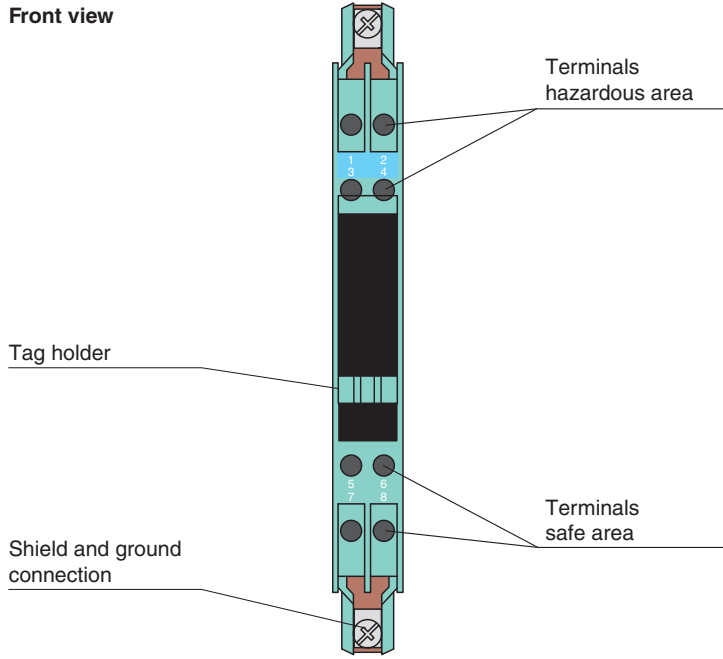



Measurement loop		max. 13.7 V at 10 $\mu$ A
<b>Conformity</b>		
Degree of protection		IEC 60529
<b>Ambient conditions</b>		
Ambient temperature		-20 ... 60 °C (-4 ... 140 °F)
Storage temperature		-25 ... 70 °C (-13 ... 158 °F)
Relative humidity		max. 75 % , without condensation
<b>Mechanical specifications</b>		
Degree of protection		IP20
Connection		screw terminals
Core cross section		max. 2 x 2.5 ... mm <sup>2</sup>
Mass		approx. 150 g
Dimensions		12.5 x 115 x 116 mm (0.5 x 4.5 x 4.6 inch) (W x H x D)
Construction type		modular terminal housing , see system description
Mounting		on 35 mm DIN mounting rail acc. to EN 60715:2001
<b>Data for application in connection with hazardous areas</b>		
EU-type examination certificate		BAS 01 ATEX 7005
Marking		Ⓜ II (1)GD, I (M1) [Ex ia Ga] IIC, [Ex ia Da] IIIC, [Ex ia Ma] I
Voltage	U <sub>o</sub>	15.75 V
Current	I <sub>o</sub>	723 mA
Power	P <sub>o</sub>	2.84 W
<b>Supply</b>		
Maximum safe voltage	U <sub>m</sub>	250 V
Series resistance		min. 21.8 $\Omega$
Certificate		TÜV 99 ATEX 1484 X
Marking		Ⓜ II 3G Ex nA IIC T4 Gc
<b>Directive conformity</b>		
Directive 2014/34/EU		EN IEC 60079-0:2018+AC:2020 , EN 60079-11:2012 , EN 60079-15:2010
<b>International approvals</b>		
<b>FM approval</b>		
Control drawing		116-0118
<b>UL approval</b>		
Control drawing		116-0139 (cULus)
<b>IECEx approval</b>		
IECEx certificate		IECEx BAS 09.0142 IECEx BAS 17.0091X
IECEx marking		[Ex ia Ga] IIC , [Ex ia Da] IIIC , [Ex ia Ma] I Ex ec IIC T4 Gc
<b>General information</b>		
Supplementary information		Observe the certificates, declarations of conformity, instruction manuals, and manuals where applicable. For information see <a href="http://www.pepperl-fuchs.com">www.pepperl-fuchs.com</a> .

**Assembly**

Front view



**Matching System Components**

	<b>ZH-ES/LB</b>	Insertion Strip
	<b>ZH-Z.AB/NS</b>	Mounting block for DIN mounting rail
	<b>ZH-Z.AB/SS</b>	Mounting block for grounding rail
	<b>ZH-Z.AK16</b>	Connection terminal for grounding rail
	<b>ZH-Z.AR.125</b>	Spacing Roller
	<b>ZH-Z.BT</b>	Label Carrier
	<b>ZH-Z.ES</b>	Single Socket
	<b>ZH-Z.LL</b>	Ground Rail Feed
	<b>ZH-Z.NLS-Cu3/10</b>	Grounding Rail
	<b>USLKG5</b>	Terminal block for equipotential bonding

Release date: 2023-04-06 Date of issue: 2023-04-06 Filename: 071897\_eng.pdf