

# Cable connector, NAMUR

## V1-W-N4-10M-PVC

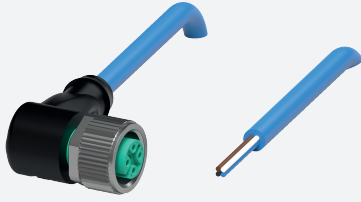

- Suitable for NAMUR technology
- Degree of protection IP68 / IP69
- Specific design protects against loosening and inaccurate installation

Female cordset single-ended M12 angled A-coded, 4-pin, PVC cable blue, NAMUR



### Dimensions

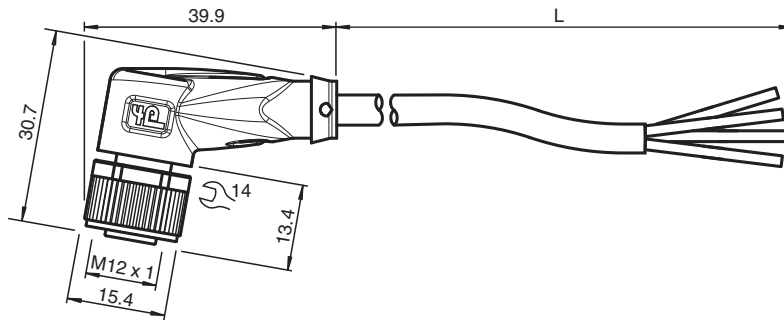

### Technical Data

#### General specifications

|                    |  |                  |
|--------------------|--|------------------|
| <b>Connector 1</b> |  |                  |
| Connection         |  | socket           |
| Construction type  |  | M12              |
| Style              |  | angled           |
| Locking            |  | screw connection |
| Number of pins     |  | 4                |
| Coding             |  | A-coded          |
| <b>Connector 2</b> |  |                  |
| Connection         |  | cable end        |

#### Electrical specifications

|                             |       |                       |
|-----------------------------|-------|-----------------------|
| Operating voltage           | $U_B$ | max. 250 V AC/DC      |
| Operating current           | $I_B$ | 4 A                   |
| Resistance per unit length  | $R'$  | max. 0.057 $\Omega/m$ |
| Capacitance per unit length | $C'$  | 88.3 nF/km            |
| Inductance per unit length  | $L'$  | 0.55 mH/km            |

#### Conformity

|                      |  |                                     |
|----------------------|--|-------------------------------------|
| Degree of protection |  | EN 60529                            |
| Plug connection      |  | connector M12 x 1 : IEC 61076-2-101 |

#### Ambient conditions

|                     |  |  |
|---------------------|--|--|
| Ambient temperature |  |  |
|---------------------|--|--|

Release date: 2023-09-04 Date of issue: 2023-09-05 Filename: 096504\_eng.pdf

## Technical Data

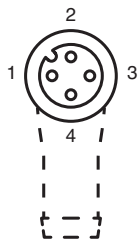

|                                  |   |   |
|----------------------------------|---|---|
| Plug connector                   |   | -40 ... 90 °C (-40 ... 194 °F)                                  |
| Cable, fixed                     |   | -25 ... 70 °C (-13 ... 158 °F)                                  |
| Cable, flexing                   |   | -5 ... 70 °C (23 ... 158 °F)                                    |
| Pollution degree                 |   | 3   |
| <b>Mechanical specifications</b> |   |   |
| Plug connector                   |   |   |
| Tightening torque                |   | 0.6 Nm  |
| Loosening protection             |   | available   |
| Tool installation                |   | straight knurling and hexagon nut SW = 14 mm                    |
| Mating cycles                    |   | min. 100  |
| Degree of protection             |   | IP68 / IP69   |
| Cable                            |   | according to IEC/EN 60228 (DIN VDE 0295) class 5                |
| Sheath diameter                  |   | 4.8 mm  |
| Bending radius                   |   | > 10 x cable diameter, fixed<br>> 15 x cable diameter, moving   |
| Sheath color                     |   | blue (similar to RAL 5015)                                      |
| Number of cores                  |   | 4   |
| Core cross section               |   | 0.34 mm <sup>2</sup>  |
| Cores color                      |   | Core 1: brown<br>Core 2: white<br>Core 3: blue<br>Core 4: black |
| Core construction                |   | 19 x 0.15 mm Ø  |
| Length                           | L | 10 m  |
| Cable code                       |   | Li YY 4 x 0,34  |
| <b>Material</b>                  |   |   |
| Plug connector                   |   |   |
| Screw connection                 |   | Zinc diecast, nickel-plated                                     |
| Body                             |   | TPU, black  |
| Seal                             |   | FKM   |
| Contact surface                  |   | gold plated (Au)  |
| Flammability                     |   | V-2   |
| Cable                            |   |   |
| Sheathing                        |   | PVC   |
| Core insulation                  |   | PVC   |

## Connection







|   |    |
|---|----|
| 1 | BN |
| 2 | WH |
| 3 | BU |
| 4 | BK |

## Accessories

|   |                          |                             |
|---|--------------------------|-----------------------------|
|  | <b>MH V1-SCREWDRIVER</b> | Torque screwdriver (0.6 Nm) |
|  | <b>MH V1-BIT M12</b>     | plug-in cap M12             |

## Accessories

|   |                              |  |
|---|------------------------------|--|
|  | <b>V1/V3-LABELHOLDER</b>     | Label holder                                     |
|  | <b>V1/V3-LABEL</b>           | Label plate                                      |
|  | <b>MH V1-Holder</b>          | Modular universal holder for M12 connectors      |
|  | <b>V1-CLIP</b>               | Unlocking protector for M12 connector            |
|  | <b>V1-MARKING-RING-COLOR</b> | Marking rings for M12 connectors, various colors |