

## Mounting flange

### BF 12-F

- For mounting cylindrical sensors with metal thread
- Secure mounting of the sensor via a snap lock
- Installation position defined by fixed stop
- Adjustable via slot mounting

Plastic mounting adapter, 12 mm

## Dimensions

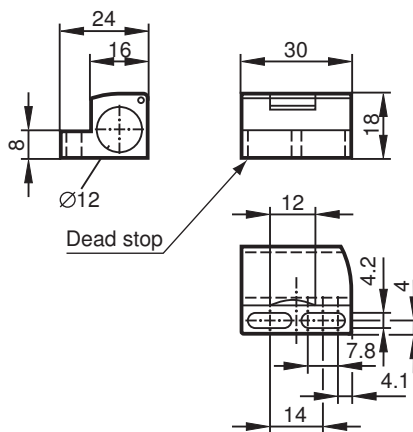

## Technical Data

### General specifications

Inside diameter 12 mm

### Ambient conditions

Ambient temperature -25 ... 85 °C (-13 ... 185 °F)

### Mechanical specifications

Material black polycarbonate (PC)

Construction type For sensors with 45° chamfer

## Mounting

### Installation

Position the mounting bracket on the desired place

Mark the position of drilling holes in the mid section of the oblong holes

Drill the mounting holes through the surface

Screw on the mounting bracket slightly via the lateral oblong holes by using suitable M4 screws

Stick the sensor through the mounting bracket and fix the sensor by the lid on the upper part of the bracket

Adjust the bracket and make the final positioning

Fix the mounting bracket finally with the screws