

Female cordset

V15-W-10M-PVC

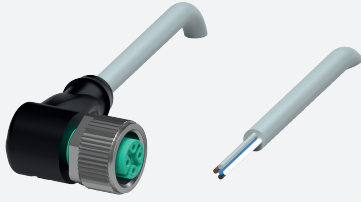

- Degree of protection IP68 / IP69
- Specific design protects against loosening and inaccurate installation

Female cordset single-ended M12 angled A-coded, 5-pin, PVC cable grey



Dimensions

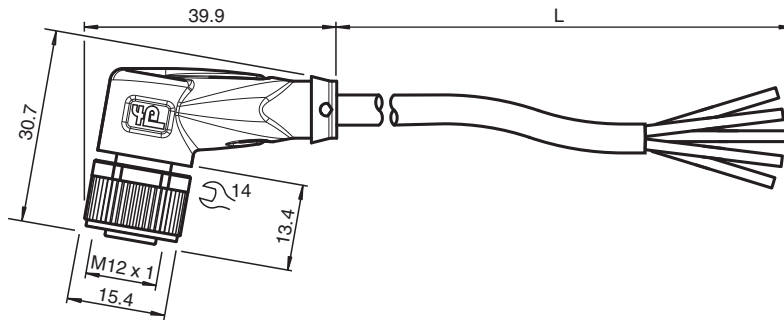

Technical Data

General specifications

| | | |
|--------------------|--|------------------|
| Connector 1 | | |
| Connection | | socket |
| Construction type | | M12 |
| Style | | angled |
| Locking | | screw connection |
| Number of pins | | 5 |
| Coding | | A-coded |
| Connector 2 | | |
| Connection | | cable end |

Electrical specifications

| | | |
|-------------------|-------|------------------------|
| Operating voltage | U_B | max. 48 V AC / 60 V DC |
| Operating current | I_B | max. 4 A |

Conformity

| | | |
|----------------------|--|-------------------------------------|
| Degree of protection | | EN 60529 |
| Plug connection | | connector M12 x 1 : IEC 61076-2-101 |

Ambient conditions

| | | |
|----------------------------|--|--------------------------------|
| Ambient temperature | | |
| Plug connector | | -40 ... 90 °C (-40 ... 194 °F) |
| Cable, fixed | | -40 ... 70 °C (-40 ... 158 °F) |
| Cable, flexing | | -5 ... 70 °C (23 ... 158 °F) |

Release date: 2023-09-04 Date of issue: 2023-09-05 Filename: 109483_eng.pdf

Technical Data

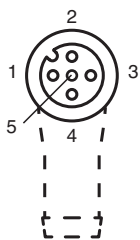

| | | |
|----------------------------------|---|---|
| Pollution degree | 3 | |
| Mechanical specifications | | |
| Plug connector | | |
| Tightening torque | | 0.6 Nm |
| Loosening protection | | available |
| Tool installation | | straight knurling and hexagon nut SW = 14 mm |
| Mating cycles | | min. 100 |
| Degree of protection | | IP68 / IP69 |
| Cable | | |
| Sheath diameter | | 4.8 mm |
| Bending radius | | > 10 x cable diameter, moving |
| Sheath stripping force | | max. 80 N / 300 mm |
| Sheath color | | grey (similar to RAL 7001) |
| Number of cores | | 5 |
| Core cross section | | 0.34 mm ² |
| Cores color | | Core 1: brown Core 2: white Core 3: blue Core 4: black Core 5: grey |
| Core construction | | 19 x 0.15 mm Ø |
| Length | L | 10 m |
| Cable code | | Li Y YM 5 x 0,34 |
| Material | | |
| Plug connector | | |
| Screw connection | | Zinc diecast, nickel-plated |
| Body | | TPU, black |
| Seal | | FKM |
| Contact surface | | gold plated (Au) |
| Flammability | | V-2 |
| Cable | | |
| Sheathing | | PVC |
| Core insulation | | PVC |
| Flammability | | flame-resistant |

Connection







| | | |
|-----|-------|----|
| 1) | | BN |
| 2) | | WH |
| 3) | | BU |
| 4) | | BK |
| 5) | | GY |

Accessories

| | | |
|---|--------------------------|-----------------------------|
|  | MH V1-SCREWDRIVER | Torque screwdriver (0.6 Nm) |
|  | MH V1-BIT M12 | plug-in cap M12 |
|  | V1/V3-LABELHOLDER | Label holder |

Accessories

| | | |
|---|------------------------------|--|
|  | V1/V3-LABEL | Label plate |
|  | MH V1-Holder | Modular universal holder for M12 connectors |
|  | V1-CLIP | Unlocking protector for M12 connector |
|  | V1-MARKING-RING-COLOR | Marking rings for M12 connectors, various colors |