

Cable connector

V1S-W-2M-PUR



- Degree of protection IP68 / IP69
- Resistant to microbes and hydrolysis
- Halogen-free
- Specific design protects against loosening and inaccurate installation

Male cordset single-ended M12 angled A-coded, 4-pin, PUR cable grey



Dimensions

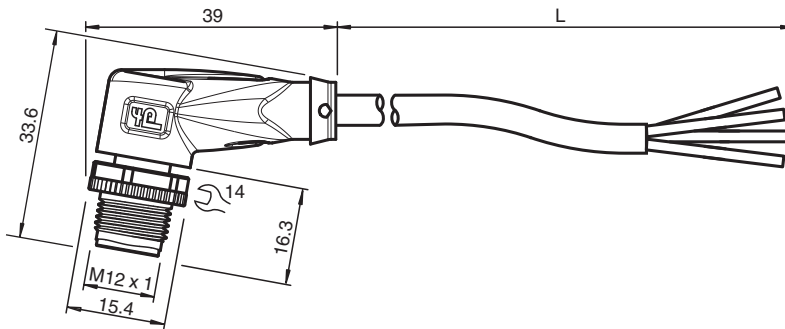

Technical Data

General specifications			
Connector 1			
Connection		plug	
Construction type		M12	
Style		angled	
Locking		screw connection	
Number of pins		4	
Coding		A-coded	
Connector 2			
Connection		cable end	
Electrical specifications			
Operating voltage	U_B	max. 250 V AC/DC	
Operating current	I_B	max. 4 A	
Conformity			
Degree of protection		EN 60529	
Plug connection		connector M12 x 1 : IEC 61076-2-101	
Halogen-free		IEC 60754-1	
Ambient conditions			
Ambient temperature			
Plug connector		-40 ... 90 °C (-40 ... 194 °F)	
Cable, fixed		-40 ... 80 °C (-40 ... 176 °F)	

Release date: 2023-09-05 Date of issue: 2023-09-05 Filename: 109740_eng.pdf

Technical Data





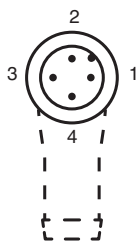

Cable, flexing	-25 ... 80 °C (-13 ... 176 °F)	
Pollution degree	3	
Mechanical specifications		
Plug connector		
Tightening torque	0.6 Nm	
Loosening protection	available	
Tool installation	straight knurling and hexagon nut SW = 14 mm	
Mating cycles	min. 100	
Degree of protection	IP68 / IP69	
Cable		
Sheath diameter	4.8 mm	
Bending radius	> 10 x cable diameter, moving > 8 x cable diameter, fixed	
Sheath stripping force	max. 60 N / 500 mm	
Sheath color	grey (similar to RAL 7001)	
Number of cores	4	
Core cross section	0.34 mm ²	
Cores color	Core 1: brown Core 2: white Core 3: blue Core 4: black	
Core construction	19 x 0.15 mm Ø	
Length	L	2 m
Cable code	Li 9Y 11YM 4 x 0.34	
Drag chain suitability		
Drag chain cycles	max. 50 / day	
Motion velocity	max. 0.3 m/s	
Material		
Halogen-free	yes	
Plug connector		
Screw connection	Zinc diecast, nickel-plated	
Body	TPU, black	
Contact surface	gold plated (Au)	
Flammability	V-2	
Cable		
Sheathing	PUR based on polyether	
Core insulation	PP	
Chemical resistance	good	
Microbial resistance	yes	
Hydrolysis resistance	yes	

Connection



1	—	BN
2	—	WH
3	—	BU
4	—	BK

Accessories

	MH V1-SCREWDRIVER	Torque screwdriver (0.6 Nm)
	MH V1-BIT M12	plug-in cap M12
	V1/V3-LABELHOLDER	Label holder
	V1/V3-LABEL	Label plate
	MH V1-Holder	Modular universal holder for M12 connectors
	V1-CLIP	Unlocking protector for M12 connector
	V1-MARKING-RING-COLOR	Marking rings for M12 connectors, various colors