

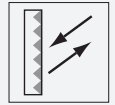

Reflector REF-H160



- Mounting holes for simple installation

Reflector, rectangular 60 mm x 18 mm, mounting holes

Dimensions

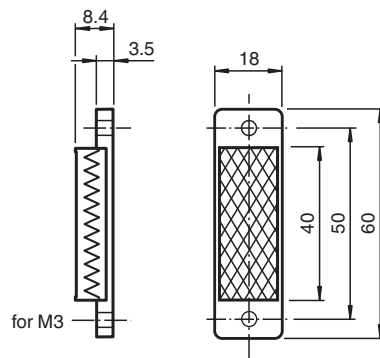

Technical Data

General specifications	
Construction type	rectangular
Ambient conditions	
Ambient temperature	-30 ... 60 °C (-22 ... 140 °F)
Mechanical specifications	
Material	PMMA/ABS
Dimensions	60 mm x 18 mm x 8.4 mm
Mounting	mounting holes

Release date: 2023-07-26 Date of issue: 2023-07-26 Filename: 113945_eng.pdf