



# Conductive Switch Amplifier

## KFA6-ER-Ex1.W.LB

- 1-channel isolated barrier
- 230 V AC supply
- Level sensing input
- Adjustable range 1 kΩ ... 150 kΩ
- Relay contact output
- Fault relay contact output
- Adjustable time delay up to 10 s
- Minimum/maximum control
- Line fault detection (LFD)



### Function

This isolated barrier is used for intrinsic safety applications. It provides the AC measuring voltage for the level sensing electrodes. Once the measured medium reaches the electrodes, the unit reacts by energizing a form C changeover relay contact. The module is voltage and temperature stabilized and guarantees a defined switching characteristic. It can be used for on/off control or minimum/maximum control. A signal delay feature is available and is adjustable between 0.5 s and 10 s. This module can also monitor the field circuit for lead breakage (LB). LB is indicated by a red LED. If LB monitoring is selected, output II serves as the fault signal output; otherwise, it will follow the function of output I.

### Application

The device is equipped with lead breakage detection (current free relay in event of failure). For this purpose, the enclosed 430 kΩ resistance must be switched between the maximum and reference electrode. This function can be deactivated by DIP switches.

### Connection

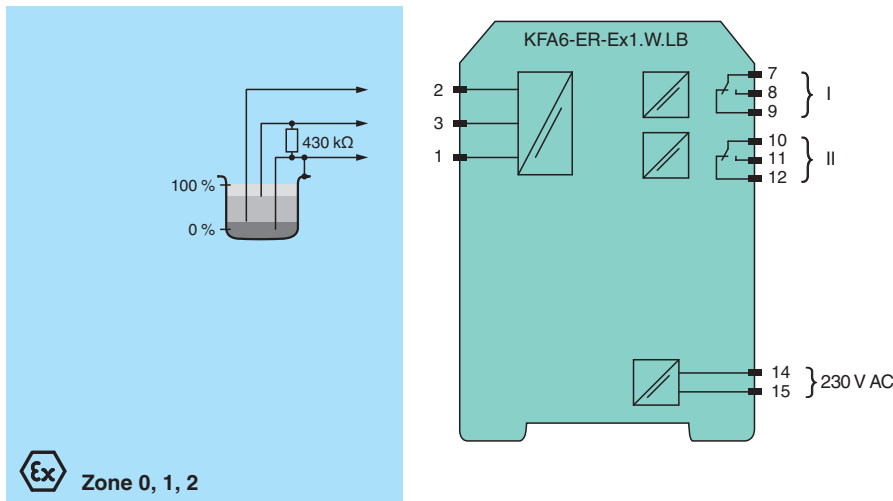

### Technical Data

General specifications	
Signal type	Digital Input
<b>Supply</b>	
Connection	terminals 14, 15
Rated voltage	$U_r$ 207 ... 253 V AC, 45 ... 65 Hz
Rated current	$I_r$ ≤ 7 mA
Power consumption	< 1.2 W

Release date: 2023-06-05 Date of issue: 2023-06-05 Filename: 115163\_eng.pdf

## Technical Data

<b>Input</b>		
Connection side		field side
Connection		terminals 1 (mass), 2 (min), 3 (max)
Control input		min./max. control system: terminals 1, 2, 3 on/off control system: terminals 1, 3
Response sensitivity		1 ... 150 k $\Omega$ , adjustable via potentiometer
<b>Output</b>		
Connection side		control side
Connection		terminals 7, 8, 9; 10, 11, 12
Switching power		max. 192 W , 2000 VA
Output		signal ; relay
Contact loading		253 V AC/2 A/cos $\phi$ > 0.7; 40 V DC/2 A resistive load
Time constant for signal damping		0.5 s, 2 s, 5 s, 10 s
<b>Galvanic isolation</b>		
Input/Output		reinforced insulation according to IEC/EN 61010-1, rated insulation voltage 300 V <sub>eff</sub>
Input/power supply		reinforced insulation according to IEC/EN 61010-1, rated insulation voltage 300 V <sub>eff</sub>
Output/power supply		reinforced insulation according to IEC/EN 61010-1, rated insulation voltage 300 V <sub>eff</sub>
<b>Indicators/settings</b>		
Display elements		LEDs
Control elements		DIP switch potentiometer
Configuration		via DIP switches via potentiometer
Labeling		space for labeling at the front
<b>Directive conformity</b>		
Electromagnetic compatibility		
Directive 2014/30/EU		EN 61326-1:2013 (industrial locations)
Low voltage		
Directive 2014/35/EU		EN 61010-1:2010
<b>Conformity</b>		
Electromagnetic compatibility		NE 21:2006
Degree of protection		IEC 60529:2001
<b>Ambient conditions</b>		
Ambient temperature		-20 ... 60 °C (-4 ... 140 °F)
<b>Mechanical specifications</b>		
Degree of protection		IP20
Connection		screw terminals , max. 2.5 mm <sup>2</sup>
Mass		approx. 150 g
Dimensions		20 x 119 x 115 mm (0.8 x 4.7 x 4.5 inch) (W x H x D) , housing type B2
Mounting		on 35 mm DIN mounting rail acc. to EN 60715:2001
<b>Data for application in connection with hazardous areas</b>		
EU-type examination certificate		DMT 00 ATEX E 032
Marking		Ⓜ II (1)G [EEx ia] IIC [circuit(s) in zone 0/1/2]
Input		[EEx ia] IIC
Voltage	U <sub>o</sub>	10 V
Current	I <sub>o</sub>	2.5 mA
Power	P <sub>o</sub>	6 mW
<b>Supply</b>		
Maximum safe voltage	U <sub>m</sub>	265 V AC (Attention! U <sub>m</sub> is no rated voltage.)
<b>Output</b>		
Contact loading		253 V AC/2 A/cos $\phi$ > 0.7; 40 V DC/2 A resistive load
<b>Galvanic isolation</b>		
Input/Output		safe electrical isolation acc. to IEC/EN 60079-11, voltage peak value 375 V
Input/power supply		safe electrical isolation acc. to IEC/EN 60079-11, voltage peak value 375 V

## Technical Data

Directive conformity	
Directive 2014/34/EU	EN 60079-0:2012+A11:2013, EN 60079-11:2012
<b>General information</b>	
Supplementary information	Observe the certificates, declarations of conformity, instruction manuals, and manuals where applicable. For information see <a href="http://www.pepperl-fuchs.com">www.pepperl-fuchs.com</a> .

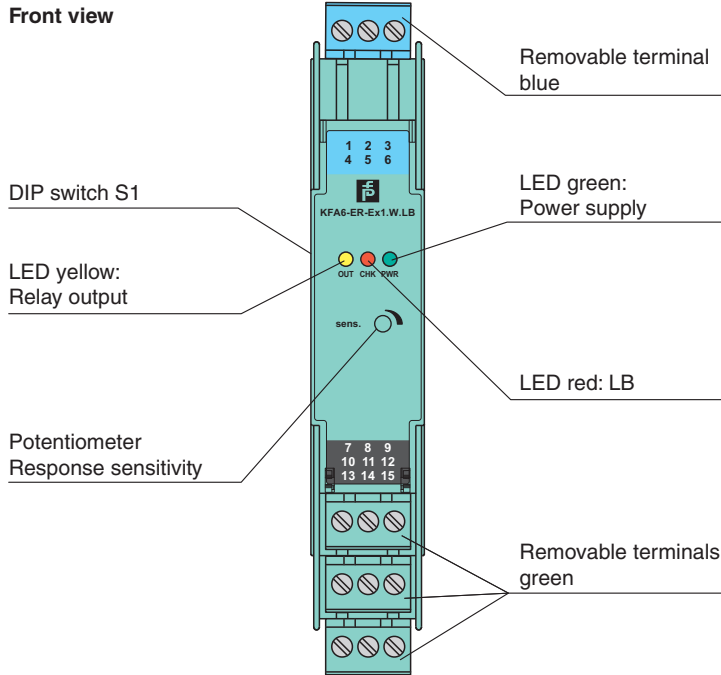

## Assembly



## Matching System Components

	<b>K-DUCT-BU</b>	Profile rail, wiring comb field side, blue
---	------------------	--

## Accessories

	<b>KF-ST-5GN</b>	Terminal block for KF modules, 3-pin screw terminal, green
	<b>KF-ST-5BU</b>	Terminal block for KF modules, 3-pin screw terminal, blue
	<b>KF-CP</b>	Red coding pins, packaging unit: 20 x 6

Release date: 2023-06-05 Date of issue: 2023-06-05 Filename: 115163\_eng.pdf

**Configuration**

DIP switch function on side of device

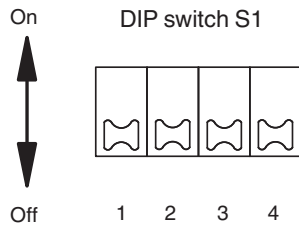

Switches	Position	Function
1	Off	open circuit current
	On	closed circuit current
2	Off	LB deactivated
	On	LB activated

Switch 3	Switch 4	Time constant for signal damping
Off	Off	0.5 s
Off	On	2 s
On	Off	5 s
On	On	10 s

- Open circuit current principle: In open circuit current principle the relay becomes active when the limit is reached.
- Closed circuit current principle: In closed circuit current principle, the relay is activated when power is applied. The relay is deactivated when the limit is reached.

Release date: 2023-06-05 Date of issue: 2023-06-05 Filename: 115163\_eng.pdf