

Thru-beam sensor

E18-LAS/EV18-LAS/25/32/76a/92



- Laser thru-beam sensor in the M18 housing
- Metal design
- Automatic threshold value adaptation
- Very high switching accuracy
- Light beam diameter < 1.5 mm
- Test input

Laser thru-beam sensor, M18 threaded housing design, metal housing, front optical face, 10 m detection range, red light, light on, DC version, PNP output, test input, M12 plug



Dimensions

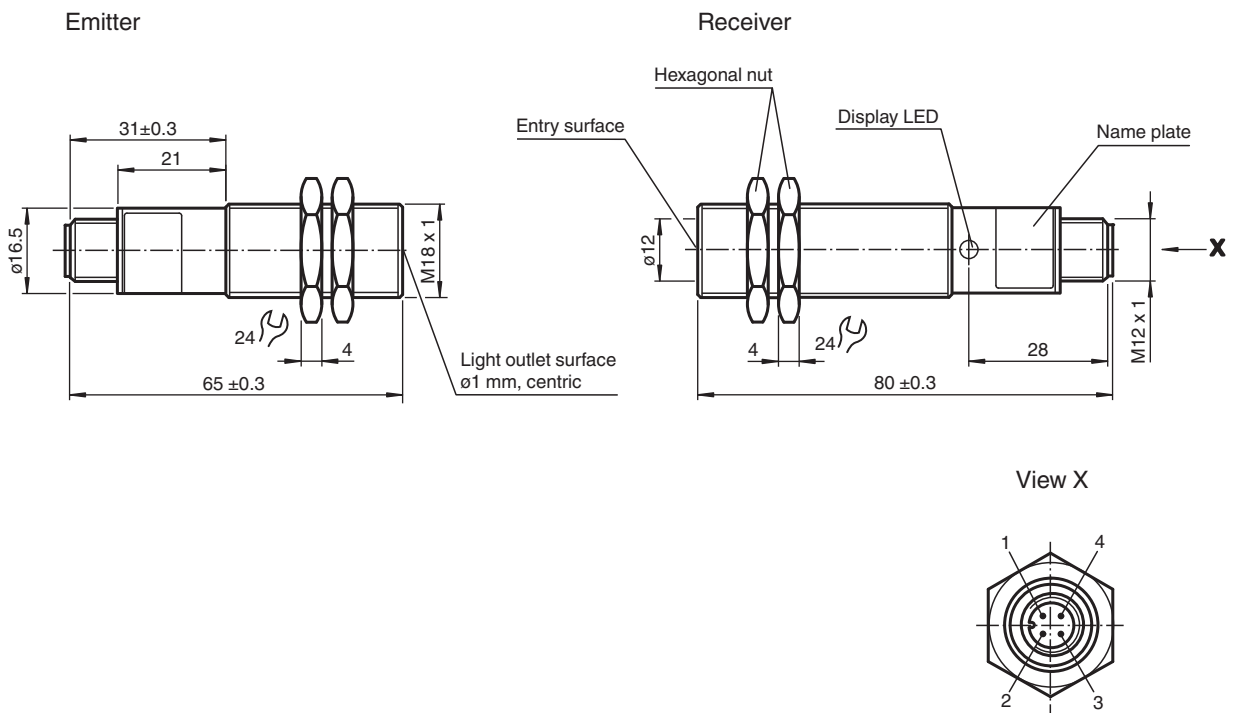

Release date: 2023-03-28 Date of issue: 2023-03-28 Filename: 115526_eng.pdf

Technical Data

System components		
Emitter		E18-LAS/92
Receiver		EV18-LAS/32/92
General specifications		
Effective detection range		0 ... 10 m
Threshold detection range		18 m
Light source		laser diode
Light type		modulated visible red light
Laser nominal ratings		
Note		LASER LIGHT , DO NOT STARE INTO BEAM
Laser class		1
Wave length		650 nm
Beam divergence		1 mrad
Pulse length		15 μ s
Repetition rate		10 kHz
max. pulse energy		< 10.2 nJ
Target size		1.2 mm
Light receiver		photo diode
Diameter of the light spot		approx. 2 mm at detection range 1.5 m
Opening angle		Receiver +/-2°
Optical face		frontal
Ambient light limit		
Continuous light		5000 Lux
Hysteresis	H	25 %
Functional safety related parameters		
MTTF _d		208.3 a
Mission Time (T _M)		7 a
Diagnostic Coverage (DC)		60 %
Indicators/operating means		
Function indicator		LED yellow, lights up when light beam is free, flashes when falling short of the operating reserve
Electrical specifications		
Operating voltage	U _B	10 ... 30 V DC
Ripple		10 %
No-load supply current	I ₀	emitter \leq 25 mA , receiver \leq 60 mA
Input		
Test input		Emitter deactivation emitter on: 0 ... +3V emitter off: +5V ... +U _B
Output		
Stability alarm output		PNP, open collector , short-circuit protected inactive: signal strength > approx. 30 % of the strength with clean optic active: signal strength < approx. 30 % of the strength with clean optic
Switching type		light-on
Signal output		1 PNP, short-circuit protected, open collector
Switching voltage		max. 30 V DC
Switching current		max. 100 mA
Switching frequency	f	1000 Hz
Response time		0.5 ms
Conformity		
Product standard		EN 60947-5-2
Laser safety		IEC 60825-1:2007
Compliance with standards and directives		
Standard conformity		
Shock and impact resistance		IEC / EN 60068, half-sine, 30 g in X, Y and Z direction

Release date: 2023-03-28 Date of issue: 2023-03-28 Filename: 115526_eng.pdf

Technical Data

Vibration resistance	IEC / EN 60068-2-6. Sinus. 10 -150 Hz, 5 g in each X, Y and Z directions
Approvals and certificates	
CCC approval	CCC approval / marking not required for products rated ≤36 V
Ambient conditions	
Ambient temperature	0 ... 50 °C (32 ... 122 °F)
Storage temperature	-40 ... 85 °C (-40 ... 185 °F)
Mechanical specifications	
Degree of protection	IP65
Connection	4-pin, M12 x 1 connector
Material	
Housing	brass, nickel-plated
Optical face	glass
Connector	metal
Mass	per 45 g

Connection Assignment

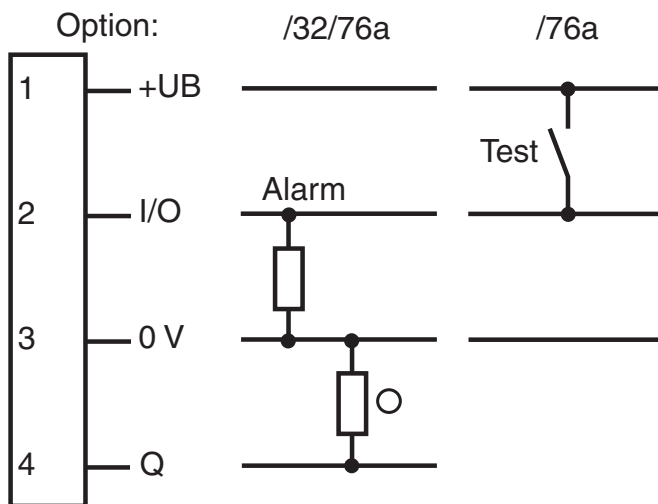

○ = Light on
● = Dark on

Connection Assignment

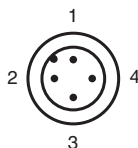

Wire colors in accordance with EN 60947-5-2

1	BN	(brown)
2	WH	(white)
3	BU	(blue)
4	BK	(black)

Release date: 2023-03-28 Date of issue: 2023-03-28 Filename: 115526_eng.pdf

Characteristic Curve

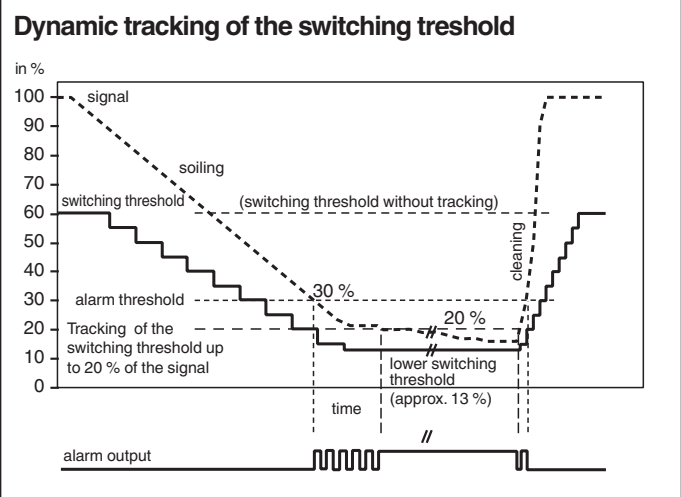
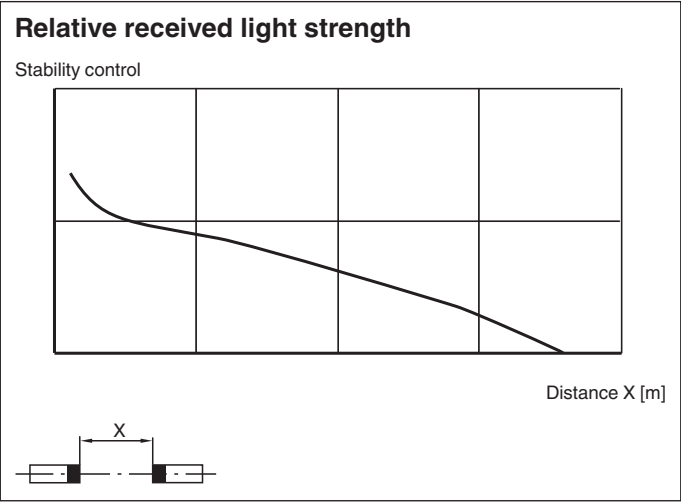
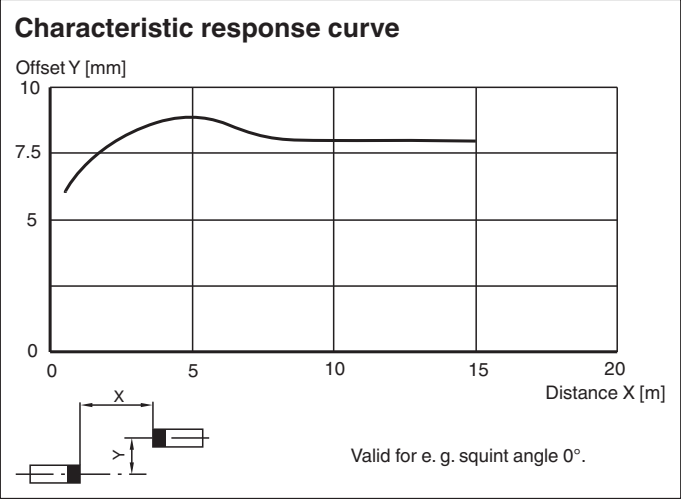

Safety Information

Laser Class 1 Information

The irradiation can lead to irritation especially in a dark environment. Do not point at people!
 Maintenance and repairs should only be carried out by authorized service personnel!
 Attach the device so that the warning is clearly visible and readable.
 The warning accompanies the device and should be attached in immediate proximity to the device.
 Caution – Use of controls or adjustments or performance of procedures other than those specified herein may result in hazardous radiation exposure.











Release date: 2023-03-28 Date of issue: 2023-03-28 Filename: 115526_eng.pdf

Technical Features

The optical barrier is equipped with an automatic adjustment of the limit value with non-volatile memory to compensate for contamination by dust particles in the optical path. The adjustment of the limit value for the switching point extends to < 20 % of the signal level that is present for the unattenuated optical path

The control constant is < 3 sec for a reduction in intensity of 2 %, or < 0.6 s (typically 0.2 sec) for an increase in intensity of 2 %.

Accessories

	CPZ18B03	Mounting Bracket with swivel nut
	OMH-VL18	Mounting Bracket with swivel nut
	BF 18	Mounting flange, 18 mm
	BF 18-F	Plastic mounting adapter, 18 mm
	BF 5-30	Universal mounting bracket for cylindrical sensors with a diameter of 5 ... 30 mm
	V1-G-2M-PVC	Female cordset single-ended M12 straight A-coded, 4-pin, PVC cable grey
	V1-G-2M-PUR	Female cordset single-ended M12 straight A-coded, 4-pin, PUR cable grey
	V1-W-2M-PUR	Female cordset single-ended M12 angled A-coded, 4-pin, PUR cable grey
	V1-G-5M-PVC	Female cordset single-ended M12 straight A-coded, 4-pin, PVC cable grey
	V1-G-5M-PUR	Female cordset single-ended M12 straight A-coded, 4-pin, PUR cable grey
	V1-W-5M-PUR	Female cordset single-ended M12 angled A-coded, 4-pin, PUR cable grey