

Mounting aid

OMH-K02

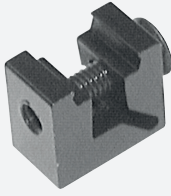

- Mounting clamp
- Simple and fast mounting

dove tail mounting clamp



Dimensions

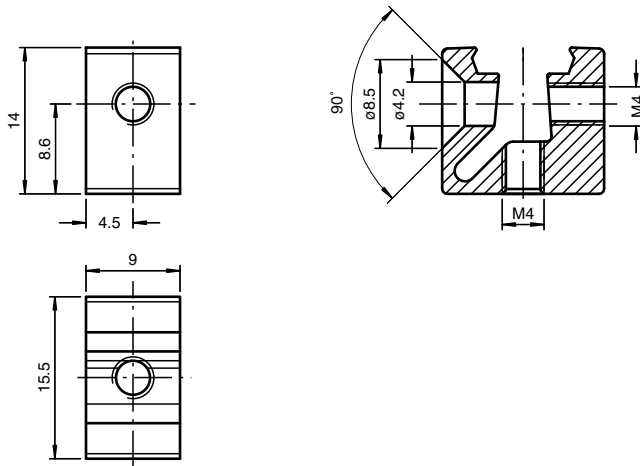

Technical Data

Mechanical specifications

Material	anodized aluminum
Mass	approx. 5 g

Suitable series

Series	MLV12
Safety Series	SL12, SLA12

Release date: 2020-03-21 | Date of issue: 2020-06-29 | Filename: 115636_eng.pdf