

Fire protection retroreflective sensor

MLV12-54-2563/49/124

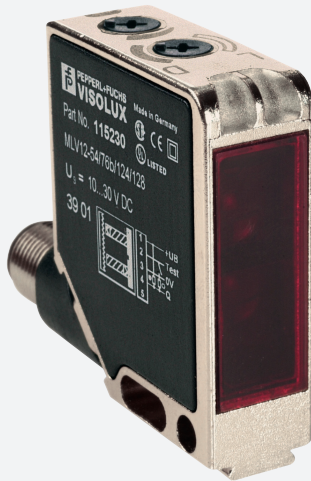

- Small fire protection photoelectric sensor for safety devices on fire barriers
- Approval in accordance with VdS Test Report FSA and externally monitored manufacture (Ü Symbol)
- High protection against contact
- Not sensitive to ambient light, even with switched energy saving lamps

Small fire protection photoelectric sensor



Function

It is essential that fire is not allowed to spread in buildings should it break out. Fire protection regulations therefore prescribe fire barriers. These include fire doors, industrial fire doors and fire dampers, which are generally kept closed at all times. In areas where doors are left open, such as heavily traveled passageways and corridors, a self-closing mechanism must be automatically triggered in case of fire. However, the door must not close when persons or objects are in the closing area. Legislation consequently requires monitoring with appropriate safety devices. The technical challenge is to ignore the smoke and at the same time reliably detect objects in it. These certified photoelectric sensors fulfill this function.

Application

- Securing hold-open devices on fire barriers in the vicinity of track-based conveyor systems
- Reliable object detection for doorway monitoring with fire barriers in the vicinity of trackbased conveyor systems, even in smoky condition

Dimensions

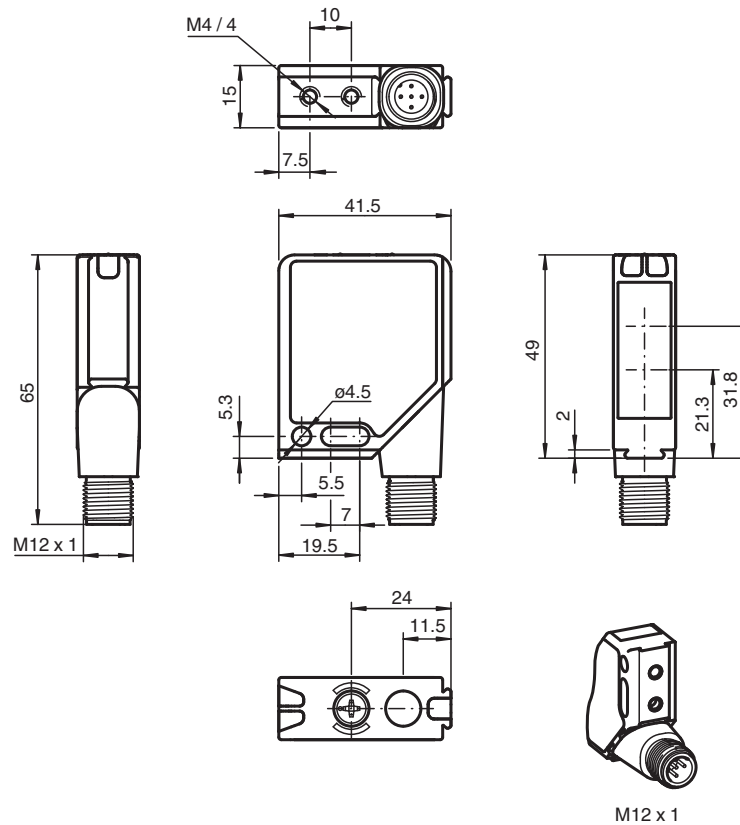

Technical Data

General specifications	
Effective detection range	0 ... 2.1 m (with H60 reflector)
Reflector distance	0.2 ... 2.1 m
Reference target	H60 reflector
Light source	LED 645 nm
Light type	modulated visible red light
Diameter of the light spot	approx. 70 mm
Angle of divergence	1.5 °
Ambient light limit	50000 Lux
Indicators/operating means	
Operation indicator	LED green, flashes in case of short-circuit
Function indicator	2 LEDs yellow, light up when light beam is free, flash when falling short of the stability control, off when light beam is interrupted
Control elements	rotary switch for light/dark
Electrical specifications	
Operating voltage	U_B 10 ... 30 V DC
Ripple	max. 10 %
No-load supply current	I_0 max. 40 mA
Protection class	II, rated voltage \leq 300 V AC with pollution degree 1-2 according to IEC 60664-1
Output	
Switching type	light/dark on switchable
Signal output	1 NPN and 1 PNP output, direct switching, short-circuit protected, reverse polarity protected, open collector

Release date: 2021-11-18 Date of issue: 2021-11-18 Filename: 118147_eng.pdf

Technical Data

Switching voltage		max. 30 V DC
Switching current		max. 0.2 A
Voltage drop	U_d	≤ 2.5 V DC
Switching frequency	f	≤ 40 Hz
Response time		10 ms
Conformity		
Product standard		EN 60947-5-2
Standard conformity		
Standards		EN 60947-5-2 smoke insensitive up to 2 dB/m (EN 54-12)
Approvals and certificates		
UL approval		cULus Listed, Class 2 Power Source, Type 1 enclosure
CCC approval		CCC approval / marking not required for products rated ≤ 36 V
Approvals		VdS/DIBt certificate of compliance No. 25020 , approval number Z-6.510-2295
Ambient conditions		
Ambient temperature		-40 ... 60 °C (-40 ... 140 °F)
Storage temperature		-40 ... 75 °C (-40 ... 167 °F)
Relative humidity		30% ... 85% non-condensing ; Non-icing
Mechanical specifications		
Degree of protection		IP67
Connection		5-pin M12 x 1 connector with metal thread, 90° rotatable
Material		
Housing		Frame: nickel plated, die cast zinc, Laterals: glass-fiber reinforced plastic PC
Optical face		Plastic pane
Mass		60 g

Connection

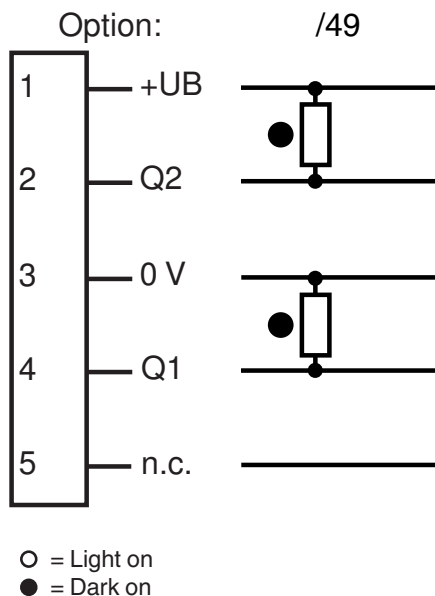

Connection Assignment

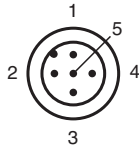

Wire colors in accordance with EN 60947-5-2

1	BN	(brown)
2	WH	(white)
3	BU	(blue)
4	BK	(black)
5	GY	(gray)

Assembly

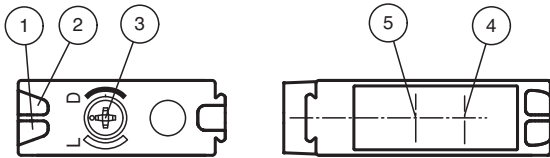

1	Operating display	green
2	Switch state	yellow
3	Light/dark switch	
4	Optical axis emitter	
5	Optical axis receiver	

Characteristic Curve

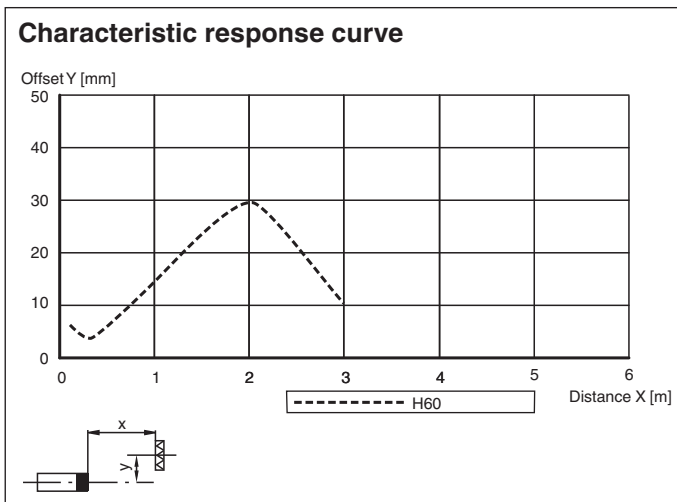

Release date: 2021-11-18 Date of issue: 2021-11-18 Filename: 118147_eng.pdf

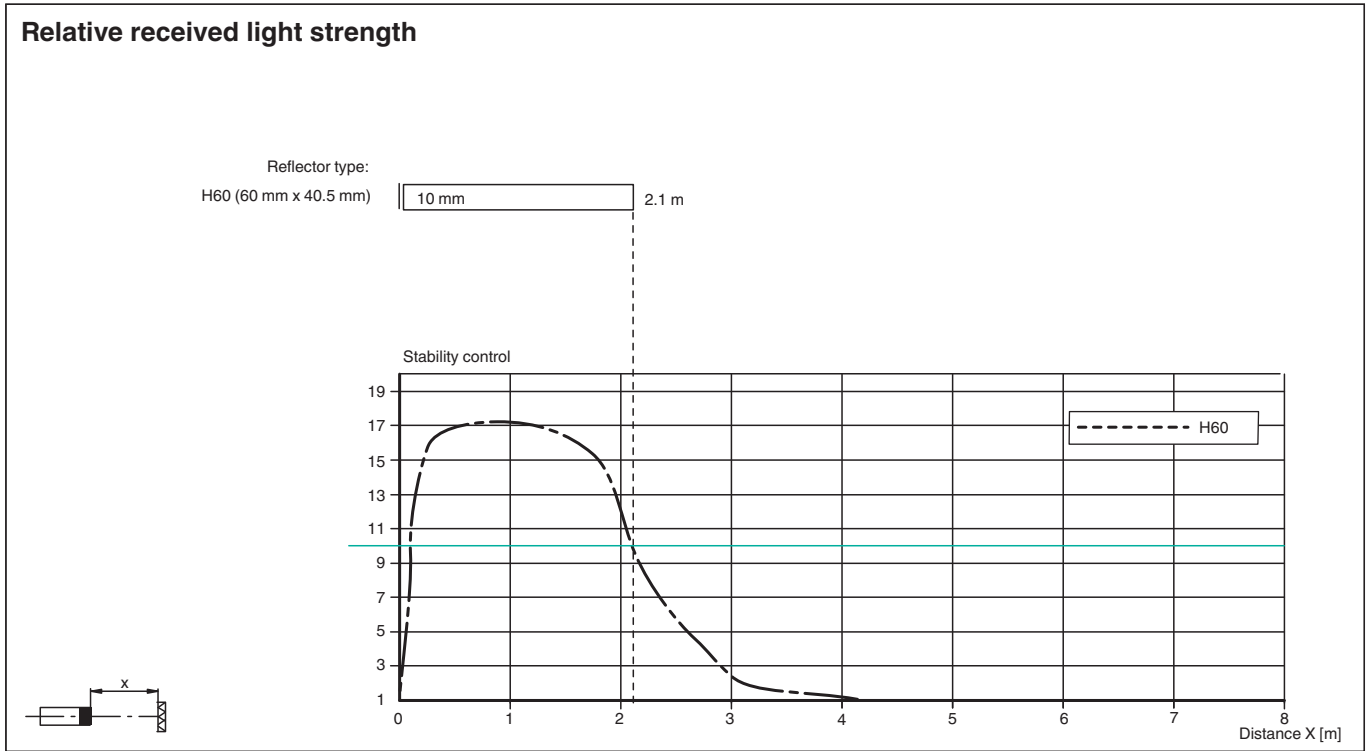

Application







Accessories

	REF-H60-2	Reflector with mounting holes
	OMH-MLV12-HWG	Mounting bracket for series MLV12 sensors
	OMH-MLV12-HWK	Mounting bracket for series MLV12 sensors
	OMH-06	Mounting aid for round steel \varnothing 12 mm or sheet 1.5 mm ... 3 mm
	OMH-K01	dove tail mounting clamp

Release date: 2021-11-18 Date of issue: 2021-11-18 Filename: 118147_eng.pdf

Accessories

	OMH-K02	dove tail mounting clamp
	OMH-K03	dove tail mounting clamp
	V15-G-2M-PUR	Female cordset single-ended M12 straight A-coded, 5-pin, PUR cable grey
	V15-G-PG9	Female connector, M12, 5-pin, field attachable
	V1-G-BK10M-PUR-U	Female cordset single-ended M12 straight A-coded, 4-pin, PUR cable black, UL approved, drag chain suitable, torsion resistant

Function Principle

The MLV12-54-2563 is a diffuse-mode photoelectric sensor with polarization filter. The diffuse-mode photoelectric sensor is an emitter and a receiver in a single housing. The emitted light is reflected back to the receiver by a reflector. When the light beam is interrupted, the switching function is triggered.

Characteristics

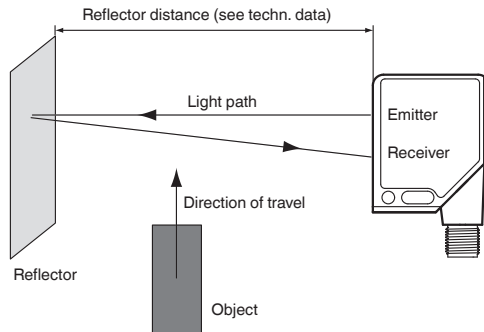

Marking

Due to its high excess gain, the MLV12-54-2563 diffuse-mode photoelectric sensor is suitable as a safety device for hold-open devices on fire barriers. The safety functionality has been tested by VdS (German Association of Property Insurers) (Test Report FSA 07009).

The MLV12-54-2563 diffuse-mode photoelectric sensor detects objects and is also insensitive to defined smoke levels (test fires 2 to 5).

The MLV12-54-2563 diffuse-mode photoelectric sensor is used as a safety device with a range of 0.2 m to 2.1 m onto the H60 reflector.