



RFID read/write device

IPH-30GM-V1

- Read/write head with thread M30 x 1.5
- Connection via V1 (M12 x 1) plug connection
- Multihole-LED for function display
- Degree of protection IP67
- For connection to IDENTControl control interface

LF RFID read/write device for IDENTControl



Dimensions

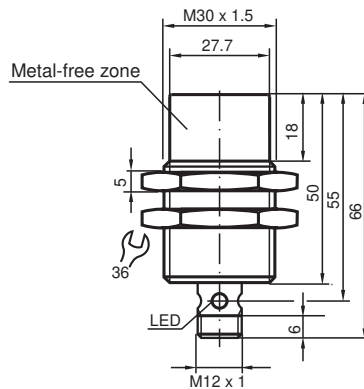

Technical Data

General specifications	
Operating frequency	125 kHz
Transfer rate	2 kBit/s
Sensing range	
Read distance	1 ... 65 mm
Write distance	1 ... 55 mm
Width	max. 55 mm
Operating distance	maximum: 70 mm
UL File Number	E87056
MTBF	350 a (Operation at +40 °C)
Indicators/operating means	
LED green/yellow	Multihole-LED: green: power on green flashing: read/write attempt performed yellow: data carrier detected
Electrical specifications	
Power consumption	$P_0 \leq 1.2 \text{ W}$
Supply	from the IDENTControl

Release date: 2023-08-08 Date of issue: 2023-08-08 Filename: 119320_eng.pdf

Technical Data

Directive conformity

Radio equipment		
Directive 2014/53/EU		EN 301489-1 EN 301489-3 EN 300330 EN 62368-1 EN 50364
RoHS		
Directive 2011/65/EU (RoHS)		IEC/EN 63000

Standard conformity

Degree of protection		EN 60529
RFID		ISO/IEC 18000-2

Ambient conditions

Ambient temperature		-25 ... 70 °C (-13 ... 158 °F)
Storage temperature		-40 ... 85 °C (-40 ... 185 °F)



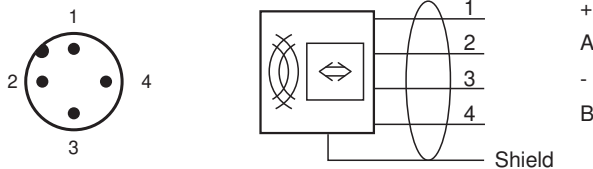

Mechanical specifications

Housing length		66 mm
Housing diameter		30 mm
Degree of protection		IP67
Connection		connector M12 x 1
Material		
Housing		PBT/stainless steel
Encapsulation compound		Fermadur
Installation		non-flush
Distance between two heads		Multiplex on: ≥ 50 mm Multiplex off: ≥ 270 mm
Mass		approx. 75 g











Connection



Accessories

	IC-KP-B6-V15B	Control interface unit IDENTControl with PROFIBUS DP interface
	IC-KP-B17-AIDA1	IDENTControl control interface with Ethernet interface for TCP/IP, PROFINET, EtherNet/IP, and MODBUS TCP protocols
	IC-KP2-2HRX-2V1	Control interface unit IDENTControl Compact with serial interface RS-232 and RS-485
	IC-KP2-2HB6-V15B	Control interface unit IDENTControl Compact with interface for PROFIBUS DP
	IC-KP2-2HB17-2V1D	IDENTControl Compact control interface with Ethernet interface for TCP/IP, PROFINET, EtherNet/IP, and MODBUS TCP protocols

Accessories

	IC-KP2-2HB21-2V1D	Control interface unit IDENTControl Compact with EtherCAT interface
	IPC02-26-T6 10pcs	Code carrier
	IPC03-C1 10pcs	Data carrier
	IPC03-12.4 10pcs	Data carrier
	IPC03-30P	Data carrier
	IPC03-58	Data carrier
	V1-G-2M-PUR-ABG-V1-W	Cordset M12 socket straight to M12 plug angled A-coded, 4-pin, PUR cable grey, shielded
	V1-G-5M-PUR-ABG-V1-W	Cordset M12 socket straight to M12 plug angled A-coded, 4-pin, PUR cable grey, shielded
	V1-G-10M-PUR-ABG-V1-W	Cordset M12 socket straight to M12 plug angled A-coded, 4-pin, PUR cable grey, shielded
	IPC03-50P	Data carrier
	IPC02-50P	Code carrier
	IPC02-12 50pcs	Code carrier