

# RFID read/write device

## IPH-L2-V1



- VariKont L<sup>(r)</sup> Type with variable alignment capability in 15° steps and front face in 90° steps
- 4 x dual LEDs on the corners for visibility on all sides
- Degree of protection IP67
- Connection via V1 (M12 x 1) plug connection
- For connection to IDENTControl control interface

LF RFID read/write device for IDENTControl



### Dimensions

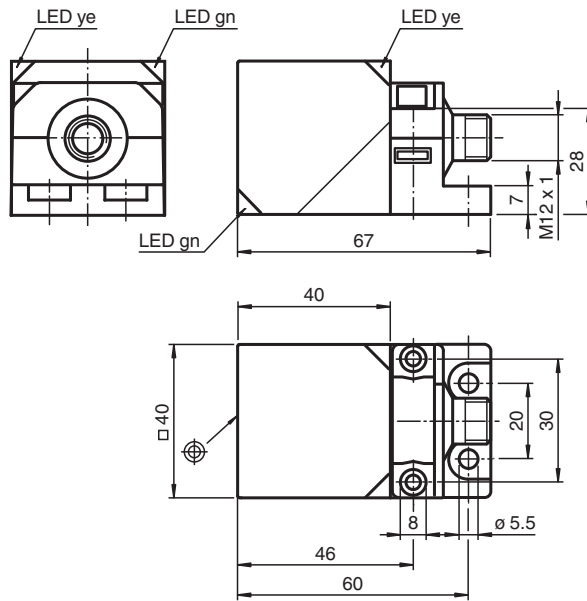

### Technical Data

#### General specifications

Operating frequency	125 kHz
Transfer rate	2 kBit/s
Sensing range	
Read distance	1 ... 75 mm
Write distance	2 ... 65 mm
Width	max. 60 mm
Operating distance	maximum: 80 mm
UL File Number	E87056
MTBF	350 a (Operation at +40 °C)

Release date: 2023-08-08 Date of issue: 2023-08-08 Filename: 119321\_eng.pdf



## Technical Data

Indicators/operating means		
LED green/yellow		green: power on green flashing: read/write attempt performed yellow: data carrier detected
Electrical specifications		
Power consumption	$P_0$	$\leq 1.2 \text{ W}$
Supply		from the IDENTControl
Directive conformity		
Radio equipment		
Directive 2014/53/EU		EN 301489-1 EN 301489-3 EN 300330 EN 62368-1 EN 50364
RoHS		
Directive 2011/65/EU (RoHS)		IEC/EN 63000
Standard conformity		
Degree of protection		EN 60529
RFID		ISO/IEC 18000-2
Ambient conditions		
Ambient temperature		-25 ... 70 °C (-13 ... 158 °F)
Storage temperature		-40 ... 85 °C (-40 ... 185 °F)
Mechanical specifications		
Housing length		55.5 mm
Housing width		40 mm
Housing height		40 mm
Degree of protection		IP67
Connection		connector M12 x 1
Material		
Housing		PA-GF35 Zinc die cast
Encapsulation compound		Fermadur
Installation		non-flush in metal
Distance between two heads		Multiplex on: $\geq 60 \text{ mm}$ Multiplex off: $\geq 450 \text{ mm}$
Mass		approx. 210 g

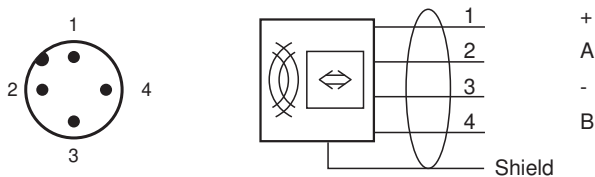













## Connection



## Accessories

	<b>IC-KP-B6-V15B</b>	Control interface unit IDENTControl with PROFIBUS DP interface
	<b>IC-KP-B17-AIDA1</b>	IDENTControl control interface with Ethernet interface for TCP/IP, PROFINET, EtherNet/IP, and MODBUS TCP protocols

## Accessories

	<b>IC-KP2-2HRX-2V1</b>	Control interface unit IDENTControl Compact with serial interface RS-232 and RS-485
	<b>IC-KP2-2HB6-V15B</b>	Control interface unit IDENTControl Compact with interface for PROFIBUS DP
	<b>IC-KP2-2HB17-2V1D</b>	IDENTControl Compact control interface with Ethernet interface for TCP/IP, PROFINET, EtherNet/IP, and MODBUS TCP protocols
	<b>IC-KP2-2HB21-2V1D</b>	Control interface unit IDENTControl Compact with EtherCAT interface
	<b>IPC02-26-T6 10pcs</b>	Code carrier
	<b>IPC03-C1 10pcs</b>	Data carrier
	<b>IPC03-12.4 10pcs</b>	Data carrier
	<b>IPC03-30P</b>	Data carrier
	<b>IPC03-58</b>	Data carrier
	<b>V1-G-2M-PUR-ABG-V1-W</b>	Cordset M12 socket straight to M12 plug angled A-coded, 4-pin, PUR cable grey, shielded
	<b>V1-G-5M-PUR-ABG-V1-W</b>	Cordset M12 socket straight to M12 plug angled A-coded, 4-pin, PUR cable grey, shielded
	<b>V1-G-10M-PUR-ABG-V1-W</b>	Cordset M12 socket straight to M12 plug angled A-coded, 4-pin, PUR cable grey, shielded
	<b>IPC03-50P</b>	Data carrier
	<b>IPC02-50P</b>	Code carrier
	<b>IPC02-12 50pcs</b>	Code carrier