



## Optical data coupler

### DAD15-8P/35



- 8 bit parallel data transfer
- Very large angle of divergence
- Can be connected in series
- Connection with spring-loaded terminals
- Degree of protection IP67

Optical data coupler



## Dimensions

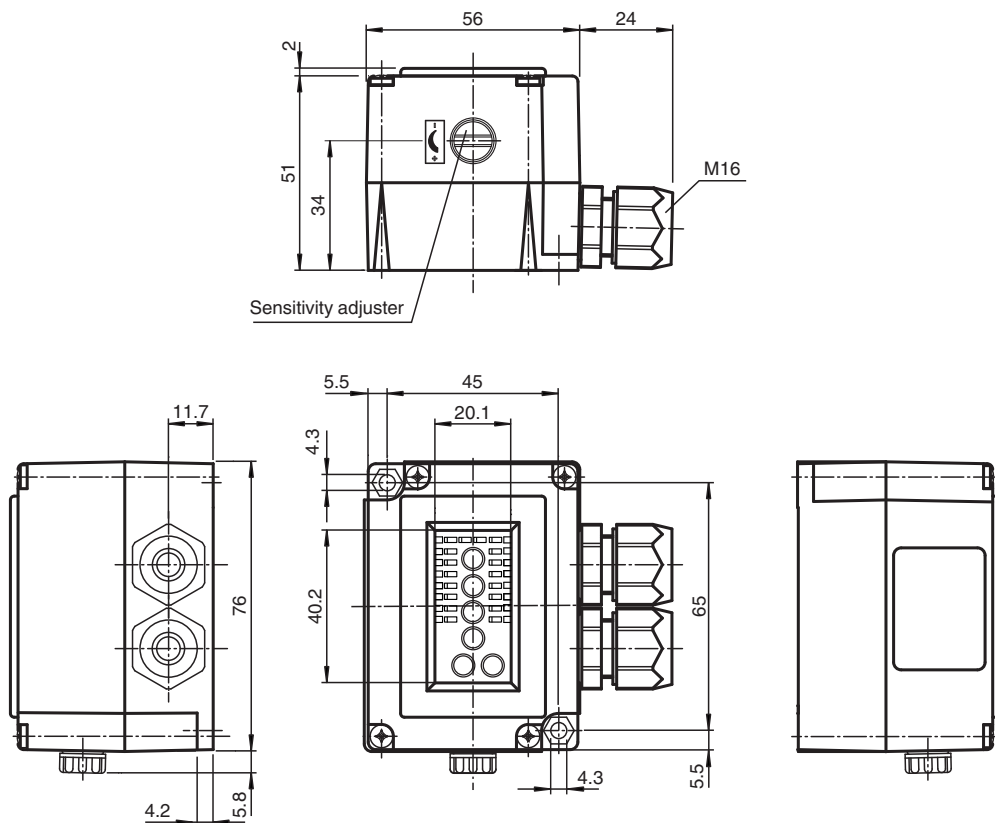

## Technical Data

### General specifications

|                           |               |
|---------------------------|---------------|
| Effective detection range | 0 ... 2500 mm |
| Threshold detection range | 5000 mm       |

Release date: 2021-11-25 Date of issue: 2021-11-25 Filename: 120839\_eng.pdf

## Technical Data

|   |  |                |
|---|--|----------------|
| Light source                                | IRED   |                |
| Light type                                  | modulated infrared light   |                |
| Diameter of the light spot                  | approx. 500 mm at 1.5 m  |                |
| Angle of divergence                         | ± 8 °  |                |
| Ambient light limit                         | 5000 Lux   |                |
| Cycle time                                  | 35 ms  |                |
| <b>Functional safety related parameters</b> |  |                |
| MTTF <sub>d</sub>                           | 200 a  |                |
| Mission Time (T <sub>M</sub> )              | 20 a   |                |
| Diagnostic Coverage (DC)                    | 0 %  |                |
| <b>Indicators/operating means</b>           |  |                |
| Operation indicator                         | LED green  |                |
| Data flow indicator                         | Inputs: 8 LEDs green<br>Outputs: 8 LEDs red                                    |                |
| Control elements                            | sensitivity adjustment   |                |
| Control elements                            | Operating mode switch 4: Behavior when beam is broken<br>Switches 1+2: Address |                |
| <b>Electrical specifications</b>            |  |                |
| Operating voltage                           | U <sub>B</sub>   | 10 ... 60 V DC |
| No-load supply current                      | I <sub>0</sub>   | 40 mA          |
| Data sampling blanking                      | Enable input emitter deactivation  |                |
| Data rate                                   | 225 Bit/s  |                |
| <b>Interface</b>                            |  |                |
| Interface type                              | 8 bit parallel, bidirectional<br>10 inputs, PNP , 10 outputs, PNP              |                |
| <b>Output</b>                               |  |                |
| Switching voltage                           | max. 60 V DC   |                |
| Switching current                           | max. 200 mA per channel , short-circuit protected , total max. 800 mA          |                |
| <b>Conformity</b>                           |  |                |
| Product standard                            | EN 60947-5-2   |                |
| <b>Approvals and certificates</b>           |  |                |
| EAC conformity                              | TR CU 020/2011   |                |
| Approvals                                   | CE   |                |
| <b>Ambient conditions</b>                   |  |                |
| Ambient temperature                         | -20 ... 60 °C (-4 ... 140 °F)  |                |
| Storage temperature                         | -20 ... 75 °C (-4 ... 167 °F)  |                |
| <b>Mechanical specifications</b>            |  |                |
| Housing width                               | 53 mm  |                |
| Housing depth                               | 56 mm  |                |
| Degree of protection                        | IP67   |                |
| Connection                                  | 2 M16 cable glands, tension spring terminals in the terminal compartment       |                |
| <b>Material</b>                             |  |                |
| Housing                                     | Terluran®, black   |                |
| Optical face                                | glass  |                |
| Mass  | 170 g  |                |

Connection Assignment

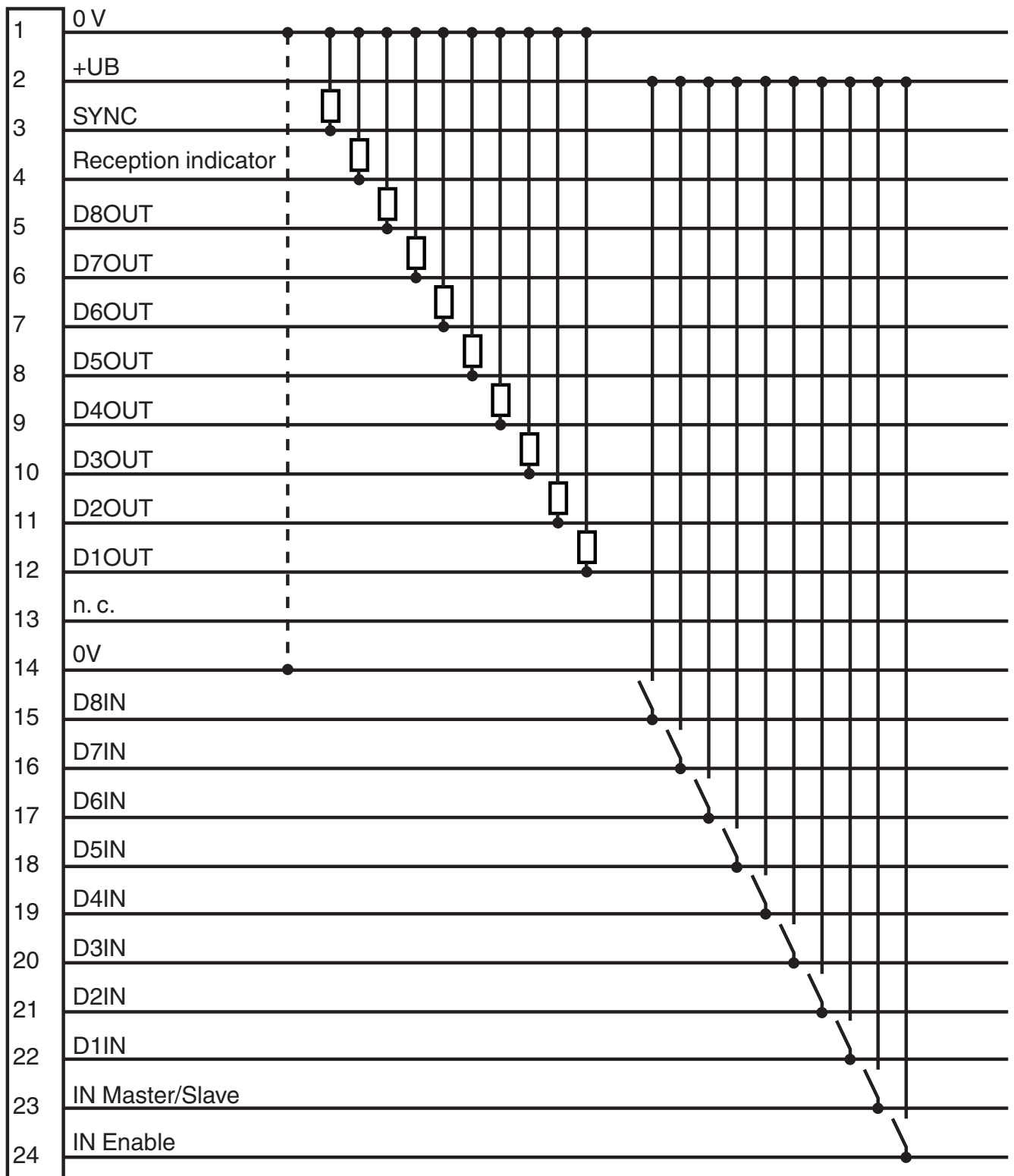

Release date: 2021-11-25 Date of issue: 2021-11-25 Filename: 120839\_eng.pdf

**Characteristic Curve**

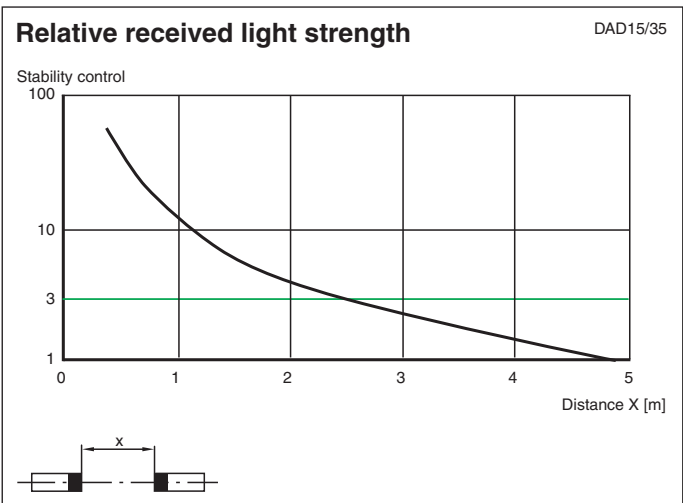
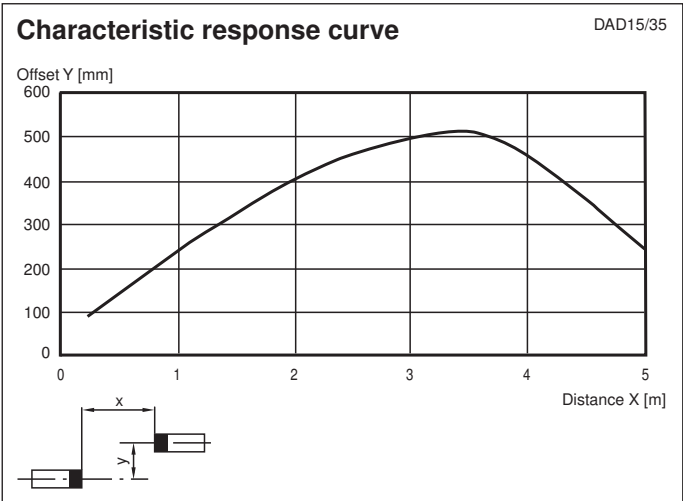

**Accessories**

|   |                  |                  |
|---|------------------|------------------|
|  | <b>OMH-DAD10</b> | Mounting bracket |
|---|------------------|------------------|

Release date: 2021-11-25 Date of issue: 2021-11-25 Filename: 120839\_eng.pdf

**Additional Information**

**Product description**

The DAD 15-8P can be used to transfer data words eight bits wide bidirectionally. A device pair is required to set up a transmission route. One device is operated as the MASTER (high level on the Master/Slave input) and the second one as the SLAVE (low level on the Master/Slave input). All binary control signals present in parallel on inputs D1 - D8 are converted serially into an 8-bit sequence in the device, are transferred over the light route and are again applied in parallel in the receiver to outputs D1 - D8. Interference-resistant PPM modulation is used to transfer binary signals. The entire cycle during which the two current 8-bit words are transferred one after the other in both directions, in the time multiplex procedure, lasts 35 ms. This corresponds to a data rate of 350 Baud. This time multiplex procedure is of no significance to the user, since the last data to be received is stored and is available on the outputs until the next change is made.

**Output behaviour when the beam of light is interrupted**

The behaviour of the data outputs when the light beam is broken can be adjusted with the aid of the 4 switch (data latch):  
 OFF: Data outputs are turned off when the light beam is broken.  
 ON: The last data to be received remains intact on the outputs when the light beam is broken.

**Input/output / emitter deactivation**

A high level on the ENABLE input is required to operate the DAD15-8P. If there is a low level on the ENABLE input, the emitter will be turned off. The ENABLE input has no function in SLAVE mode.

**Inputs and outputs, reception indicator**

The states of data inputs and outputs are displayed individually via LEDs. A high level on the input is indicated by a green LED. A red LED indicates an active output. Correct reception is indicated with the output and the RECEPTION INDICATOR LED. The SYNC output indicates the end of a transmit or receive cycle. Output data are valid with a falling edge and new input data can be read.

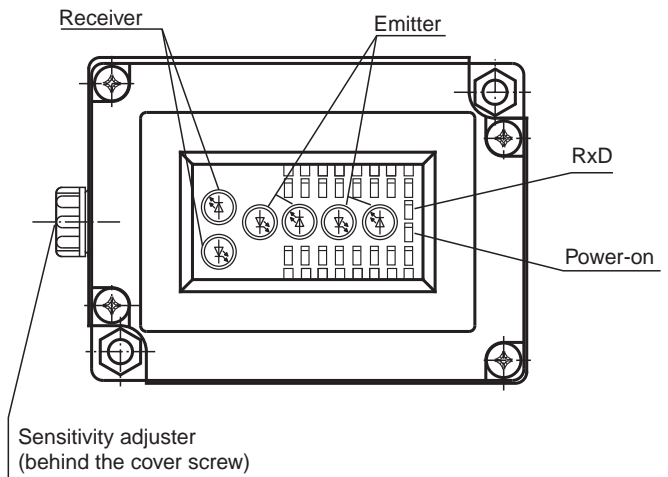

**Chaining**

The SYNC output can also be used to start an additional ENABLE input. Up to four MASTERS can be chained together in this manner. The devices must then be addressed by means of the A1 and A2 address switches. The SLAVE belonging to the MASTER in question requires the same address switch setting.

**Arrangement and mounting**

The DAD15 data light barrier consists of an electronics unit with spring-loaded terminals and 2 M16 cable glands. The electronics unit is connected with an internal connector. It is also fastened to it with 4 screws.

**Accessories**

OMH-DAD10 mounting angle

**Timing**

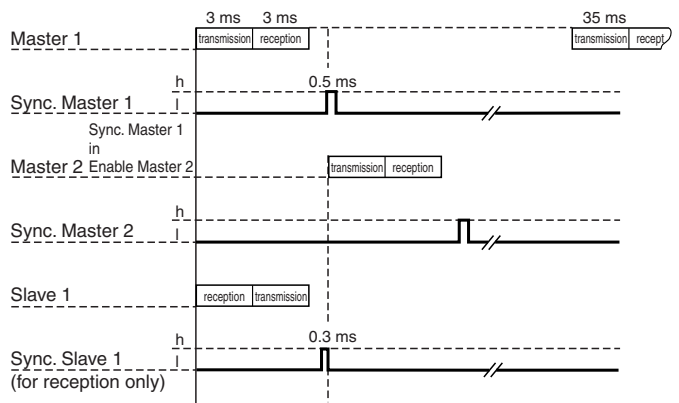

Release date: 2021-11-25 Date of issue: 2021-11-25 Filename: 120839\_eng.pdf