



## RFID read/write device

### IPH-FP-V1

- Connection via V1 (M12 x 1) plug connection
- Dual-LED for function display
- Degree of protection IP67
- For connection to IDENTControl control interface

LF RFID read/write device for IDENTControl



## Dimensions

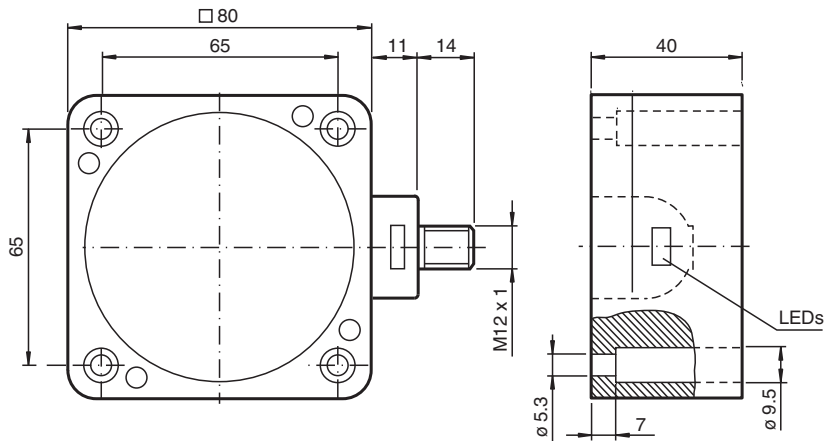

## Technical Data

General specifications	
Operating frequency	125 kHz
Transfer rate	2 kBit/s
Sensing range	
Read distance	0 ... 100 mm
Write distance	0 ... 80 mm
Width	max. 80 mm
Operating distance	maximum: 100 mm
UL File Number	E87056
MTBF	350 a (Operation at +40 °C)
Indicators/operating means	
LED green/yellow	green: power on green flashing: read/write attempt performed yellow: data carrier detected
Electrical specifications	
Power consumption	$P_0 \leq 1.2 \text{ W}$
Supply	from the IDENTControl
Directive conformity	

Release date: 2023-08-08 Date of issue: 2023-08-08 Filename: 126055\_eng.pdf



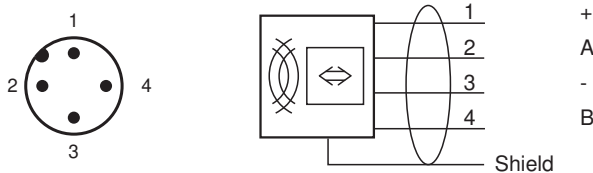

## Technical Data

<b>Radio equipment</b>	
Directive 2014/53/EU	EN 301489-1 EN 301489-3 EN 300330 EN 62368-1 EN 50364
<b>RoHS</b>	
Directive 2011/65/EU (RoHS)	IEC/EN 63000
<b>Standard conformity</b>	
Degree of protection	EN 60529
RFID	ISO/IEC 18000-2
<b>Ambient conditions</b>	
Ambient temperature	-25 ... 70 °C (-13 ... 158 °F)
Storage temperature	-40 ... 85 °C (-40 ... 185 °F)
<b>Mechanical specifications</b>	
Housing length	113 mm
Housing width	80 mm
Housing height	40 mm
Degree of protection	IP67
Connection	connector M12 x 1
<b>Material</b>	
Housing	PBT
Base	diecast aluminum
Encapsulation compound	Fermadur
<b>Installation</b>	
Distance between two heads	Multiplex on: ≥ 100 mm Multiplex off: ≥ 550 mm
Mass	approx. 380 g











## Connection



## Accessories

	<b>IC-KP-B6-V15B</b>	Control interface unit IDENTControl with PROFIBUS DP interface
	<b>IC-KP-B17-AIDA1</b>	IDENTControl control interface with Ethernet interface for TCP/IP, PROFINET, EtherNet/IP, and MODBUS TCP protocols
	<b>IC-KP2-2HRX-2V1</b>	Control interface unit IDENTControl Compact with serial interface RS-232 and RS-485
	<b>IC-KP2-2HB6-V15B</b>	Control interface unit IDENTControl Compact with interface for PROFIBUS DP
	<b>IC-KP2-2HB17-2V1D</b>	IDENTControl Compact control interface with Ethernet interface for TCP/IP, PROFINET, EtherNet/IP, and MODBUS TCP protocols

## Accessories

	<b>IC-KP2-2HB21-2V1D</b>	Control interface unit IDENTControl Compact with EtherCAT interface
	<b>IPC02-26-T6 10pcs</b>	Code carrier
	<b>IPC03-C1 10pcs</b>	Data carrier
	<b>IPC03-12.4 10pcs</b>	Data carrier
	<b>IPC03-30P</b>	Data carrier
	<b>IPC03-58</b>	Data carrier
	<b>V1-G-2M-PUR-ABG-V1-W</b>	Cordset M12 socket straight to M12 plug angled A-coded, 4-pin, PUR cable grey, shielded
	<b>V1-G-5M-PUR-ABG-V1-W</b>	Cordset M12 socket straight to M12 plug angled A-coded, 4-pin, PUR cable grey, shielded
	<b>V1-G-10M-PUR-ABG-V1-W</b>	Cordset M12 socket straight to M12 plug angled A-coded, 4-pin, PUR cable grey, shielded
	<b>IPC03-50P</b>	Data carrier
	<b>IPC02-50P</b>	Code carrier
	<b>IPC02-12 50pcs</b>	Code carrier