



## Ultrasonic sensor UC2000-30GM-IUR2-T-V15

- Parameterization interface for the application-specific adjustment of the sensor setting via the service program ULTRA 3000
- Analog current and voltage output
- Synchronization options
- Adjustable acoustic power and sensitivity
- Temperature compensation

Single head system



### Dimensions

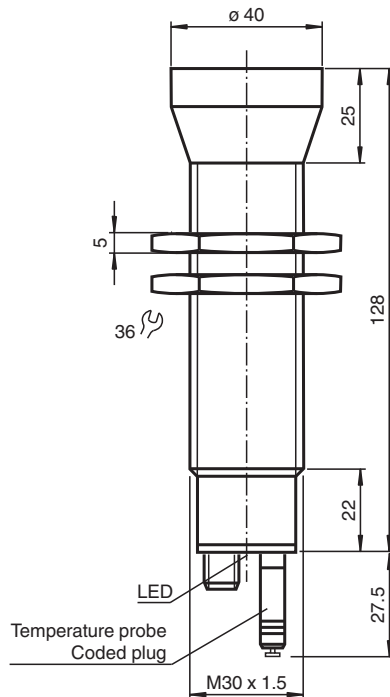

### Technical Data

#### General specifications

|                       |   |
|-----------------------|---|
| Sensing range         | 80 ... 2000 mm                          |
| Adjustment range      | 120 ... 2000 mm                         |
| Dead band             | 0 ... 80 mm                             |
| Standard target plate | 100 mm x 100 mm                         |
| Transducer frequency  | approx. 175 kHz                         |
| Response delay        | 65 ms minimum<br>195 ms factory setting |

#### Indicators/operating means

|           |   |
|-----------|---|
| LED green | solid: Power-on<br>flashing: Standby mode or program function object detected |
|-----------|---|

Release date: 2025-06-12 Date of issue: 2025-06-15 Filename: 129684\_eng.pdf

## Technical Data

|   |       |  |
|---|-------|--|
| LED yellow 1                                    |       | solid: object in evaluation range<br>flashing: program function  |
| LED yellow 2                                    |       | solid: object in detection range<br>flashing: program function   |
| LED red   |       | solid: temperature/program plug not connected<br>flashing: fault or program function object not detected   |
| Temperature/teach-in connector                  |       | Temperature compensation , Evaluation range programming , output function setting  |
| <b>Electrical specifications</b>                |       |  |
| Operating voltage                               | $U_B$ | 10 ... 30 V DC , ripple 10 % <sub>SS</sub>   |
| Power consumption                               | $P_0$ | ≤ 900 mW   |
| Time delay before availability                  | $t_v$ | ≤ 500 ms   |
| <b>Interface</b>                                |       |  |
| Interface type                                  |       | RS 232, 9600 Bit/s , no parity, 8 data bits, 1 stop bit  |
| <b>Input/Output</b>                             |       |  |
| Synchronization                                 |       | bi-directional<br>0 level: $-U_B \dots +1$ V<br>1 level: $+4$ V $\dots +U_B$<br>input impedance: > 12 KOhm<br>synchronization pulse: ≥ 100 μs, synchronization interpulse period: ≥ 2 ms |
| Synchronization frequency                       |       |  |
| Common mode operation                           |       | max. 30 Hz   |
| Multiplex operation                             |       | ≤ 30 Hz / n , n = number of sensors , n ≤ 5  |
| <b>Output</b>                                   |       |  |
| Output type                                     |       | 1 current output 4 ... 20 mA<br>1 voltage output 0 ... 10 V  |
| Resolution                                      |       | evaluation range [mm]/4000, but ≥ 0.35 mm  |
| Deviation of the characteristic curve           |       | ≤ 0.2 % of full-scale value  |
| Repeat accuracy                                 |       | ≤ 0.1 % of full-scale value  |
| Load impedance                                  |       | current output: ≤ 500 Ohm<br>voltage output: ≥ 1000 Ohm  |
| Temperature influence                           |       | ≤ 2 % from full-scale value (with temperature compensation)<br>≤ 0.2 %/K (without temperature compensation)  |
| <b>Compliance with standards and directives</b> |       |  |
| Standard conformity                             |       |  |
| Standards                                       |       | EN IEC 60947-5-2:2020<br>IEC 60947-5-2:2019<br>EN 60947-5-7:2003<br>IEC 60947-5-7:2003   |
| <b>Approvals and certificates</b>               |       |  |
| UL approval                                     |       | cULus Listed, General Purpose  |
| CCC approval                                    |       | CCC approval / marking not required for products rated ≤36 V   |
| <b>Ambient conditions</b>                       |       |  |
| Ambient temperature                             |       | -25 ... 70 °C (-13 ... 158 °F)   |
| Storage temperature                             |       | -40 ... 85 °C (-40 ... 185 °F)   |
| <b>Mechanical specifications</b>                |       |  |
| Connection type                                 |       | Connector plug M12 x 1 , 5-pin   |
| Degree of protection                            |       | IP65   |
| <b>Material</b>                                 |       |  |
| Housing   |       | stainless steel (1.4305 / AISI 303)<br>PBT plastic parts   |
| Transducer                                      |       | epoxy resin/hollow glass sphere mixture; polyurethane foam   |
| Mass  |       | 210 g  |
| <b>Dimensions</b>                               |       |  |
| Length  |       | 114 mm   |
| Diameter  |       | 30 mm  |
| <b>Factory settings</b>                         |       |  |

**Technical Data**

|        |  |
|--------|--|
| Output | evaluation limit A1: 200 mm<br>evaluation limit A2: 2000 mm<br>rising ramp |
|--------|--|

**Connection Assignment**

**Standard symbol/Connection:**

(version IU)

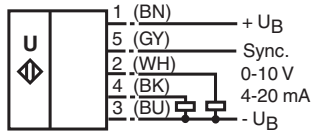

Core colors in accordance with EN 60947-5-2.

**Connection Assignment**

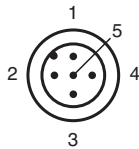

**Characteristic Curve**

**Characteristic response curve**

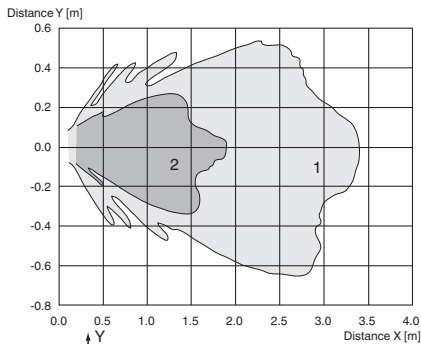

Curve 1: flat surface 100 mm x 100 mm  
Curve 2: round bar, Ø 25 mm

**Analogue output function**

**Analog function**

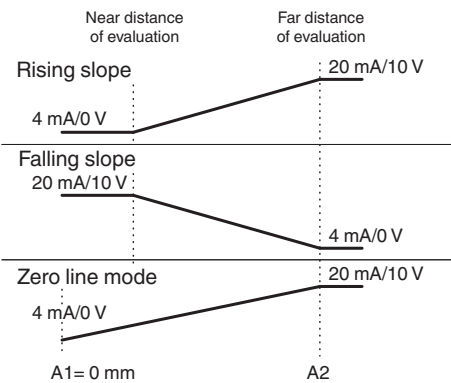

Release date: 2025-06-12 Date of issue: 2025-06-15 Filename: 129684\_eng.pdf

## Programming

### Programming procedure

The sensor features 2 programmable analog outputs with programmable evaluation range. Programming the evaluation range and the operating mode is done either via the sensor's RS232 interface and ULTRA3000 software (see the ULTRA3000 software description) or by means of the programming plug at the sensor's back end which is described here.



### Programming of Evaluation Range

1. Disconnect supply voltage
2. Remove the programming plug to activate program mode.
3. Reconnect supply voltage (Reset)
4. Place the target at the desired position for A1
5. Momentarily insert the programming plug in position A1 and then remove. This will program the position A1.
6. Place the target at the desired position for A2
7. Momentarily insert the programming plug in position A2 and then remove. This will program the position A2.

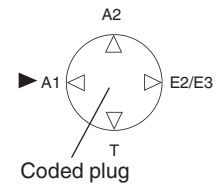

### Notes:

- Removing the programming plug saves the new position into the device memory.
- The programming status is indicated by the LED. A flashing green LED indicates that the target is detected; a flashing red LED indicates that no target is detected.

### Programming the Operation Mode

If the program mode is still activated, continue at number 4. If not, activate program mode by performing the sequence numbers 1 to 3.

1. Disconnect supply voltage
2. Remove the programming plug to activate program mode.
3. Reconnect supply voltage (Reset)
4. Insert the programming plug in position E2/E3. By removing and reinserting the plug, the user can toggle through the three different modes of operation. The selected mode is indicated by the LEDs as shown below:
  - Rising slope mode, LED A2 flashes
  - Falling slope mode, LED A1 flashes
  - Zero line mode, LEDs A1 and A2 flash
5. Once the desired mode is selected, insert the programming plug in position T. This completes the programming procedure and saves the switch points and mode of operation.
6. The sensor now operates in normal mode.

### Note:

The programming plug also functions as the temperature compensation. If the programming plug has not been inserted in the T position within 5 minutes, the sensor will return to normal operating mode with the latest saved values, without temperature compensation.

## Factory Setting

### Factory settings

See technical data.

## Indication

The sensor provides LEDs to indicate various conditions.

|  | Green LED  | Red LED   | Yellow LED A1   | Yellow LED A2   |
|--|--|---|---|---|
| <b>During Normal Operation</b><br>- Temperature compensated<br>- with removed programming plug<br>Interference (e.g. compressed air)   | On<br>Off<br>Off                                     | Off<br>On<br>Flashing                                   | Object in evaluation range<br>Object in evaluation range<br>remains in previous state | Object in sensing range<br>Object in sensing range<br>remains in previous state |
| <b>During Sensor Programming</b><br>Evaluation limit A1:<br>Object detected<br>No object detected<br>Evaluation limit A2:<br>Object detected<br>No object detected<br>Operation mode:<br>Rising slope mode<br>Falling slope mode<br>Zero line mode | Flashing<br>Off<br>Flashing<br>Off<br>On<br>On<br>On | Off<br>Flashing<br>Flashing<br>Off<br>Off<br>Off<br>Off | Flashing<br>Flashing<br>Off<br>Off<br>Off<br>Flashing<br>Flashing                     | Off<br>Off<br>Flashing<br>Flashing<br>Flashing<br>Off<br>Flashing               |
| <b>Standby</b>   | Flashing   | Off   | remains in previous state   | remains in previous state   |

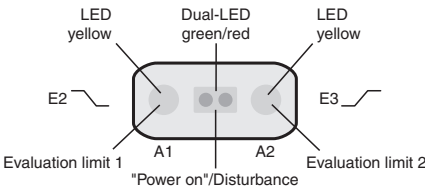

## Commissioning

### Synchronization

This sensor features a synchronization input for suppressing ultrasonic mutual interference ("cross talk"). If this input is not connected, the sensor will operate using internally generated clock pulses. It can be synchronized by applying an external square wave. The pulse duration must be  $\geq 100 \mu s$ . Each falling edge of the synchronization pulse triggers transmission of a single ultrasonic pulse. If the synchronization signal remains low for  $\geq 1$  second, the sensor will revert to normal operating mode. Normal operating mode can also be activated by opening the signal connection to the synchronization input (see note below).

If the synchronization input goes to a high level for  $> 1$  second, the sensor will switch to standby mode, indicated by the green LED. In this mode, the outputs will remain in the last valid output state.

**Note:**

If the option for synchronization is not used, the synchronization input has to be connected to ground (0 V) or the sensor must be operated via a V1 cordset (4-pin).

The synchronization function cannot be activated during programming mode and vice versa.

**The following synchronization modes are possible:**

- Several sensors (max. number see technical data) can be synchronized together by interconnecting their respective synchronization inputs. In this case, each sensor alternately transmits ultrasonic pulses in a self multiplexing mode. No two sensors will transmit pulses at the same time (see note below).
- Multiple sensors can be controlled by the same external synchronization signal. In this mode the sensors are triggered in parallel and are synchronized by a common external synchronization pulse.
- A separate synchronization pulse can be sent to each individual sensor. In this mode the sensors operate in external multiplex mode (see note below).
- A high level ( $+U_B$ ) on the synchronization input switches the sensor to standby mode.

**Note:**

Sensor response times will increase proportionally to the number of sensors that are in the synchronization string. This is a result of the multiplexing of the ultrasonic transmit and receive signal and the resulting increase in the measurement cycle time.

## Additional Information

### Note on communication with the UC-30GM-R2 interface cable

The UC-30GM-R2 interface cable allows for communication with the ultrasonic sensor using ULTRA3000 software. The cable creates a connection between a PC RS-232 interface and the programming plug socket on the sensor. When connecting to the sensor, make certain the plug is lined up correctly; otherwise no communication will be possible. The key of the cable's plug must be aligned to the groove of the socket on the sensor (not with the arrow symbol on the sensor).

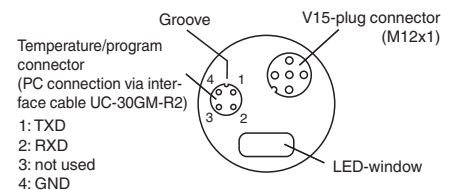

**Programmable parameters with the ULTRA3000 software**

- Evaluation limits A1 and A2
- Operation mode
- Sonic speed
- Temperature offset (The inherent temperature-rise of the sensor can be considered in the temperature compensation)
- Expansion of the unusable area (for suppression of unusable area echoes)
- Reduction of the detection range (for suppression of remote range echoes)

Release date: 2025-06-12 Date of issue: 2025-06-15 Filename: 129684\_eng.pdf

- Time of measuring cycle
- Acoustic power (interference of the burst duration)
- Sensitivity
- Behavior of the sensor in case of echo loss
- Behavior of the sensor in case of a fault
- Average formation via an allowed number of measuring cycles
- Selection of the parameter set, RS 232 or manually

**Note:**

When connected to a PC and running the ULTRA3000 software, the sensor can act as a long term data logger as well.

## Installation Conditions

If the sensor is installed in an environment where the temperature can fall below 0 °C, one of these mounting flanges must be used for mounting: BF30, BF30-F, or BF 5-30.

If it is intended to operate the sensor at - 25 °C, we recommend discussing the mounting situation with a Pepperl + Fuchs application specialist to ensure a trouble-free operation.

If the sensor is mounted in a through hole using the included steel nuts, it must be mounted at the middle of the threaded housing. If it must be mounted at the front end of the threaded housing, plastic nuts with centering ring (optional accessories) must be used.