

Connection cable

V11-W-2M-PVC-V11-G



- Degree of protection IP68 / IP69
- Specific design protects against loosening and inaccurate installation

Cordset M12 socket angled to M12 plug straight A-coded, 3-pin, PVC cable grey



Dimensions

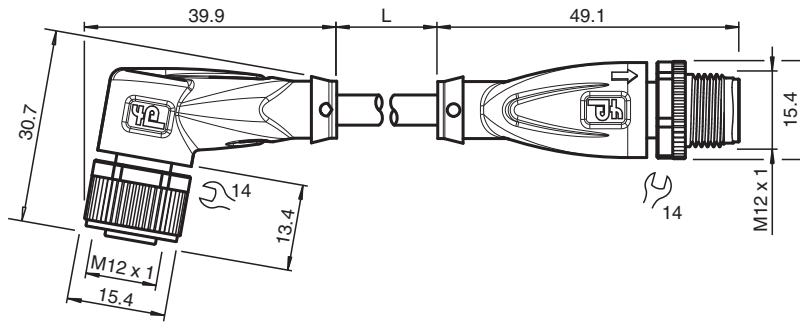

Technical Data

General specifications

Connector 1		
Connection		socket
Construction type		M12
Style		angled
Locking		screw connection
Number of pins		3
Coding		A-coded
Connector 2		
Connection		plug
Construction type		M12
Style		straight
Locking		screw connection
Number of pins		3
Coding		A-coded
Electrical specifications		
Operating voltage	U_B	max. 250 V AC/DC
Operating current	I_B	max. 4 A
Conformity		
Degree of protection		EN 60529
Plug connection		connector M12 x 1 : IEC 61076-2-101

Release date: 2023-07-10 Date of issue: 2023-07-10 Filename: 129955_eng.pdf

Technical Data

Ambient conditions

Ambient temperature	
Plug connector	-40 ... 90 °C (-40 ... 194 °F)
Cable, fixed	-25 ... 70 °C (-13 ... 158 °F)
Cable, flexing	-5 ... 70 °C (23 ... 158 °F)
Pollution degree	3

Mechanical specifications

Plug connector	
Tightening torque	0.6 Nm
Loosening protection	available
Tool installation	straight knurling and hexagon nut SW = 14 mm
Mating cycles	min. 100
Degree of protection	IP68 / IP69
Cable	according to IEC/EN 60228 (DIN VDE 0295) class 5
Sheath diameter	4.8 mm
Bending radius	> 10 x cable diameter, moving
Sheath stripping force	max. 80 N / 300 mm
Sheath color	grey (similar to RAL 7001)
Number of cores	3
Core cross section	0.34 mm ²
Cores color	Core 1: brown Core 3: blue Core 4: black
Core construction	19 x 0.15 mm Ø
Length	L 2 m
Cable code	Li Y YM 3 x 0,34

Material

Plug connector	
Screw connection	Zinc diecast, nickel-plated
Body	TPU, black
Seal	FKM
Contact surface	gold plated (Au)
Flammability	V-2
Cable	
Sheathing	PVC
Core insulation	PVC
Flammability	flame-resistant



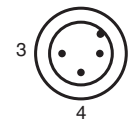
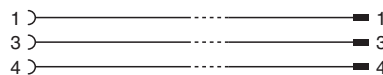
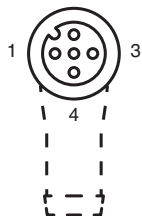



Connection



Accessories

	MH V1-SCREWDRIVER	Torque screwdriver (0.6 Nm)
---	--------------------------	-----------------------------

Accessories

	MH V1-BIT M12	plug-in cap M12
	V1/V3-LABELHOLDER	Label holder
	V1/V3-LABEL	Label plate
	MH V1-Holder	Modular universal holder for M12 connectors
	V1-CLIP	Unlocking protector for M12 connector
	V1-MARKING-RING-COLOR	Marking rings for M12 connectors, various colors