

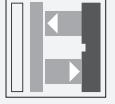

Background suppression sensor

RL28-8-H-700-IR/47/105/106



- Universal series with highly versatile fields of use
- Resistant against noise: reliable operation under all conditions
- Minimal black-white difference through the infrared transmission LED
- Version with heated front panel

Background suppression sensor



Function

The series 28 family of sensors can be universally used. It has a large range of models that allows it to be integrated into any automation environment. The sensors are contained in sturdy water resistant plastic housings with multiple fastening options and scratch resistant optical cover. Features such as a timer function, and functions including a light/dark switch, sensitivity adjuster and highly visible status LEDs make for less effort on the part of the user and streamline installation, setup and operation. Just about any task associated with positioning, moving, conveying and monitoring can be accomplished with these sensors.

Application

- Object tracking in material handling, and the packaging sector
- Material flow monitoring
- Bin occupancy check in storage technology
- Fine positioning in high-bay warehouses
- Presence and height monitoring on pallet conveyors
- Single-beam protection for automatic industrial gates and elevator doors
- Protection at automatic gates

Dimensions

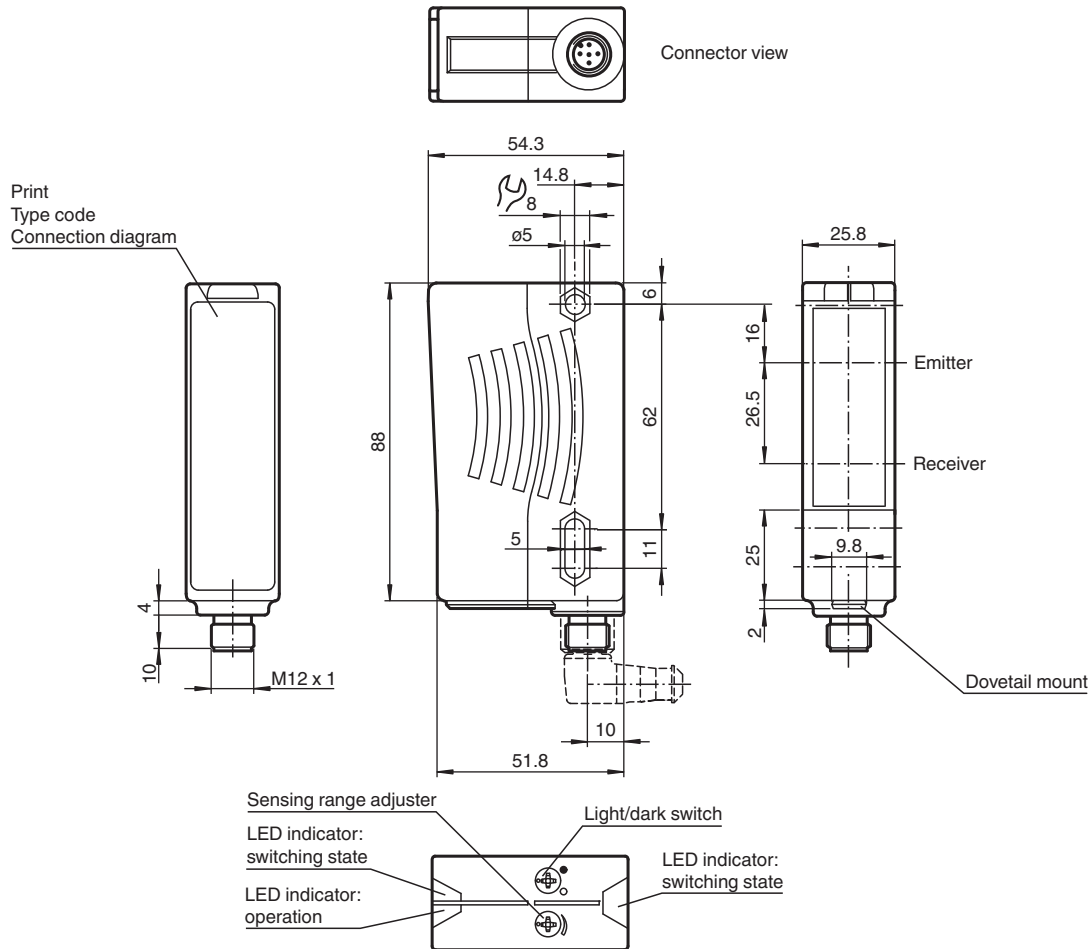

Technical Data

General specifications

Detection range	20 ... 700 mm
Detection range min.	20 ... 200 mm
Detection range max.	20 ... 700 mm
Background suppression	max. + 10 % of the upper limit of the detection range
Light source	IRED
Light type	modulated infrared light , 880 nm
Black-white difference (6 %/90 %)	< 8 %
Diameter of the light spot	approx. 24 mm at a distance of 700 mm
Opening angle	transmitter 2° receiver 2°
Ambient light limit	50000 Lux

Functional safety related parameters

MTTF _d	720 a
Mission Time (T _M)	20 a
Diagnostic Coverage (DC)	0 %

Indicators/operating means

Operation indicator	LED green
Function indicator	2 LEDs yellow ON: object inside the scanning range OFF: object outside the scanning range
Control elements	Sensing range adjuster , Light-on/dark-on changeover switch

Electrical specifications

Technical Data

Operating voltage	U_B	24 V DC \pm 20 %
Ripple		10 %
No-load supply current	I_0	\leq 40 mA
Output		
Switching type		light/dark on switchable
Signal output		2 PNP, complementary, short-circuit protected, reverse polarity protected , open collectors
Switching voltage		max. 30 V DC
Switching current		max. 200 mA
Switching frequency	f	250 Hz
Response time		2 ms
Conformity		
Product standard		EN 60947-5-2
Approvals and certificates		
Protection class		II, rated voltage \leq 250 V AC with pollution degree 1-2 according to IEC 60664-1
UL approval		E87056 , cULus Listed , class 2 power supply , type rating 1
Ambient conditions		
Ambient temperature		-40 ... 60 °C (-40 ... 140 °F)
Storage temperature		-40 ... 60 °C (-40 ... 140 °F)
Mechanical specifications		
Housing width		25.8 mm
Housing height		88 mm
Housing depth		54.3 mm
Degree of protection		IP67
Connection		5-pin, M12 x 1 connector
Material		
Housing		Plastic ABS
Optical face		Plastic pane
Mass		70 g
Note		Heated lens

Connection Assignment

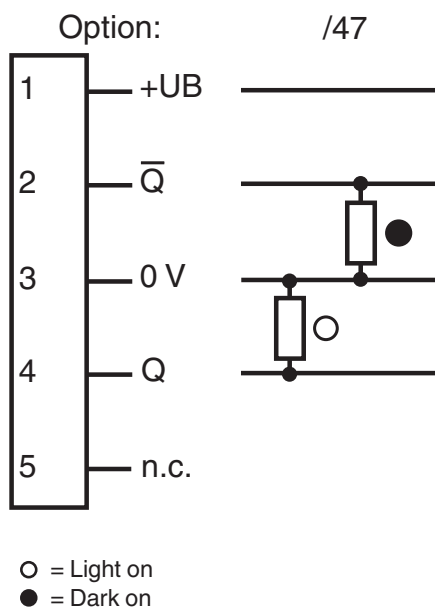

Connection Assignment

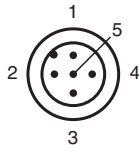

Wire colors in accordance with EN 60947-5-2

- | | | |
|---|----|---------|
| 1 | BN | (brown) |
| 2 | WH | (white) |
| 3 | BU | (blue) |
| 4 | BK | (black) |
| 5 | GY | (gray) |

Assembly

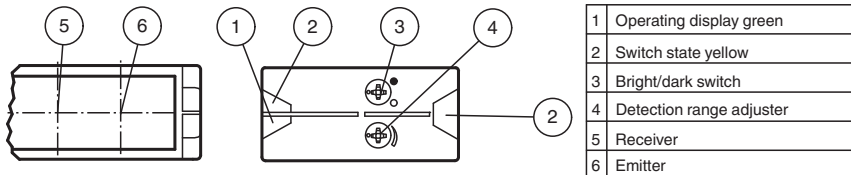

Characteristic Curve

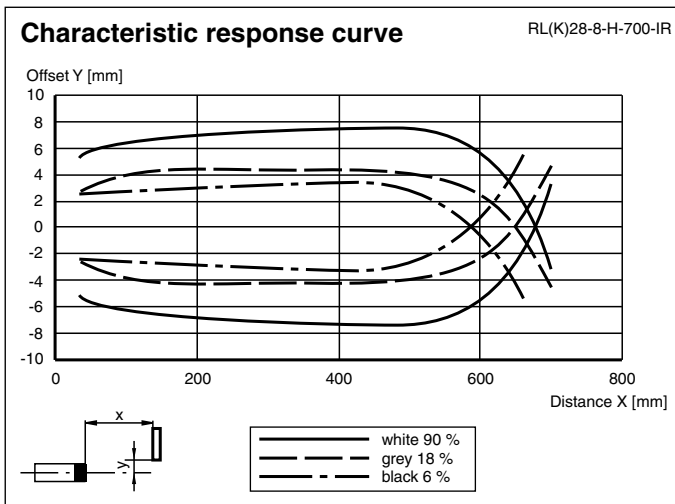

Release date: 2023-04-04 Date of issue: 2023-04-04 Filename: 132449_eng.pdf



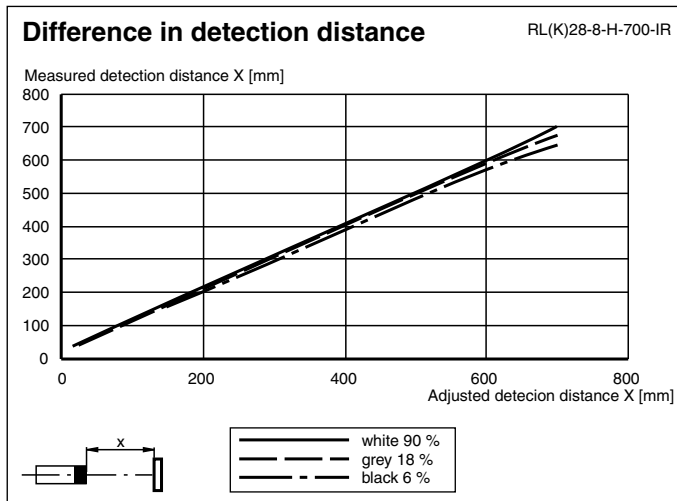

Characteristic Curve



Application



Accessories

	OMH-05	Mounting aid for round steel \varnothing 12 mm or sheet 1.5 mm ... 3 mm
	OMH-21	Mounting bracket: mounting aid for sensors in the RL* series
	OMH-22	Mounting aid for RL* series
	OMH-RLK29-HW	Mounting bracket for rear wall mounting
	OMH-RL28-C	Weld slag cover model

Additional Information

Mounting instructions:

There are two bore holes for mounting the sensor with M5 bolts. The base surface must be flat to avoid distorting the housing during mounting. It is advisable to secure the bolts with spring washers so that the sensor does not become misaligned.

Outdoor installation:

The sensor must be protected against rain and splash-water, possibly must a cover be installed.

Adjustment:

Adjust the sensor on the background. After the connecting to the power supply the green LED illuminates. In case the yellow LEDs illuminate too, the detection range needs to be reduced with the detection range adjuster, until the yellow LEDs is switched off. If the object is moved into the detection range the yellow LEDs illuminates.

Driving inductive loads:

If the sensor are used to drive inductive loads, the following safety procedures must be carried out:

For operating voltage of 10 V DC ... 30 V DC: fit a protection diode, max. 200 mA