



## Retroreflective sensor RL28-55/47/82b/105/106



- Universal series with highly versatile fields of use
- Resistant against noise: reliable operation under all conditions
- Version with red light
- Version with heated front panel

Retroreflective sensor with polarization filter



### Function

The series 28 family of sensors can be universally used. It has a large range of models that allows it to be integrated into any automation environment. The sensors are contained in sturdy water resistant plastic housings with multiple fastening options and scratch resistant optical cover. Features such as a timer function, and functions including a light/dark switch, sensitivity adjuster and highly visible status LEDs make for less effort on the part of the user and streamline installation, setup and operation. Just about any task associated with positioning, moving, conveying and monitoring can be accomplished with these sensors.

### Application

- Object tracking in material handling, and the packaging sector
- Material flow monitoring
- Bin occupancy check in storage technology
- Fine positioning in high-bay warehouses
- Presence and height monitoring on pallet conveyors
- Single-beam protection for automatic industrial gates and elevator doors
- Protection at automatic gates

## Dimensions

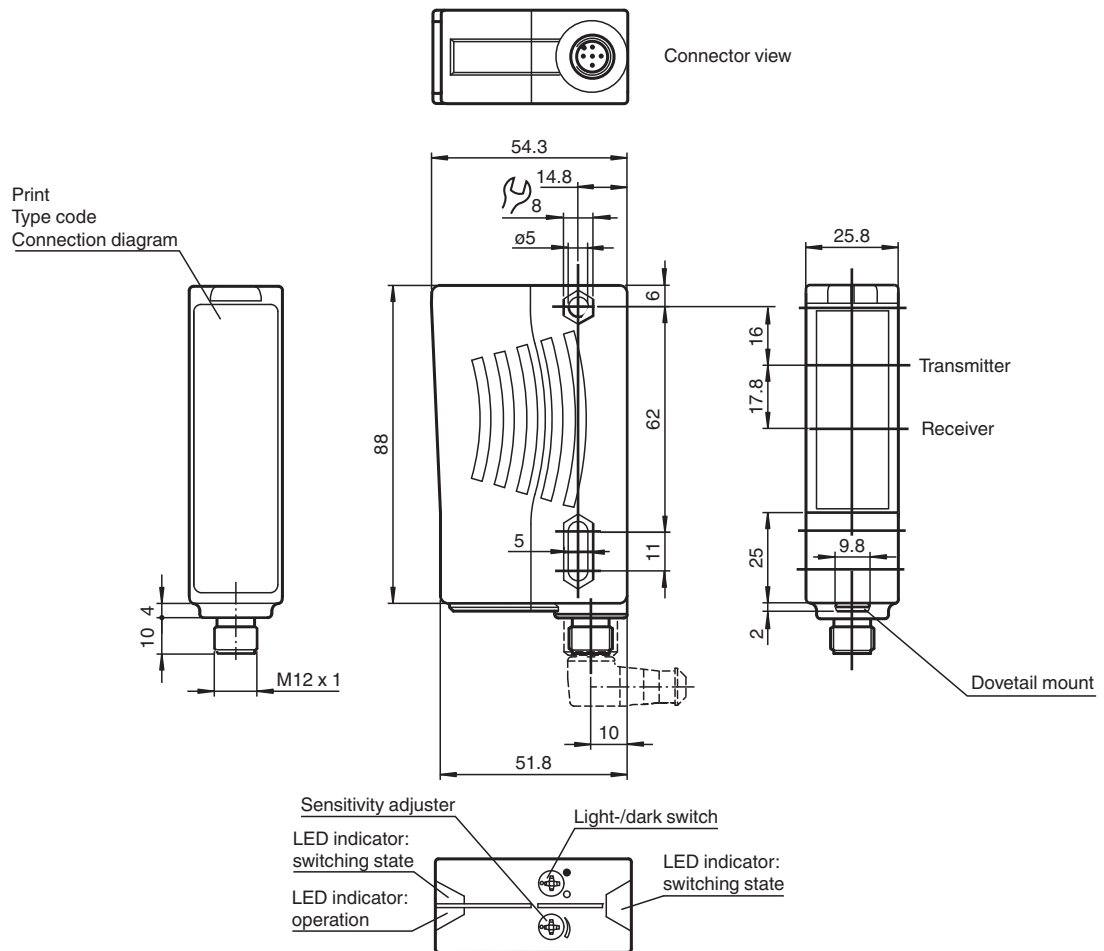

## Technical Data

General specifications	
Effective detection range	0 ... 17 m
Reflector distance	0.05 ... 17 m
Threshold detection range	21 m
Reference target	H85-2 reflector
Light source	LED
Light type	modulated visible red light
Polarization filter	yes
Diameter of the light spot	approx. 290 mm at a distance of 17 m
Opening angle	emitter 1.2° receiver 2°
Ambient light limit	80000 Lux
Functional safety related parameters	
MTTF <sub>d</sub>	950 a
Mission Time (T <sub>M</sub> )	20 a
Diagnostic Coverage (DC)	0 %
Indicators/operating means	
Operation indicator	LED green
Function indicator	2 LEDs yellow, light up when light beam is free, flash when falling short of the stability control, off when light beam is interrupted
Control elements	sensitivity adjustment (Adjustment to < 25% of the effective operating range) , Light-on/dark-on changeover switch
Electrical specifications	

## Technical Data

Operating voltage	$U_B$	24 V DC $\pm$ 20 %
Ripple		10 %
No-load supply current	$I_0$	$\leq$ 70 mA
<b>Output</b>		
Stability alarm output		1 PNP, inactive when falling short of the stability control for 10;s immediately inactive if 4 light beam interruptions take place
Switching type		light/dark on switchable
Signal output		2 PNP, complementary, short-circuit protected, reverse polarity protected , open collectors
Switching voltage		max. 30 V DC
Switching current		max. 2 A
Switching frequency	f	1000 Hz
Response time		0.5 ms
<b>Conformity</b>		
Product standard		EN 60947-5-2
<b>Approvals and certificates</b>		
EAC conformity		TR CU 020/2011
Protection class		II, rated voltage $\leq$ 250 V AC with pollution degree 1-2 according to IEC 60664-1
UL approval		E87056 , cULus Listed , class 2 power supply , type rating 1
<b>Ambient conditions</b>		
Ambient temperature		-40 ... 60 °C (-40 ... 140 °F)
Storage temperature		-40 ... 60 °C (-40 ... 140 °F)
<b>Mechanical specifications</b>		
Housing width		25.8 mm
Housing height		88 mm
Housing depth		54.3 mm
Degree of protection		IP67
Connection		5-pin, M12 x 1 connector
<b>Material</b>		
Housing		Plastic ABS
Optical face		Plastic pane
Mass		70 g
Note		Heated lens

## Connection Assignment

Option: /47/82b

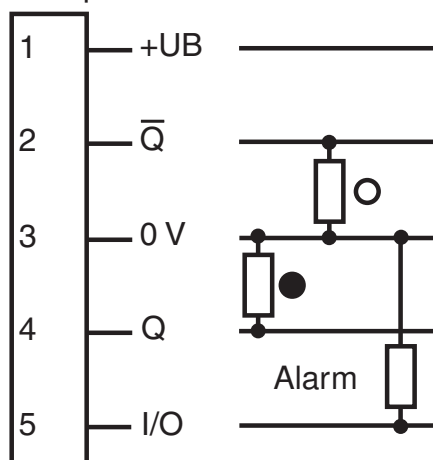

- = Light on
- = Dark on

**Connection Assignment**

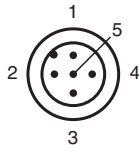

Wire colors in accordance with EN 60947-5-2

1	BN	(brown)
2	WH	(white)
3	BU	(blue)
4	BK	(black)
5	GY	(gray)

**Characteristic Curve**

**Characteristic response curve**

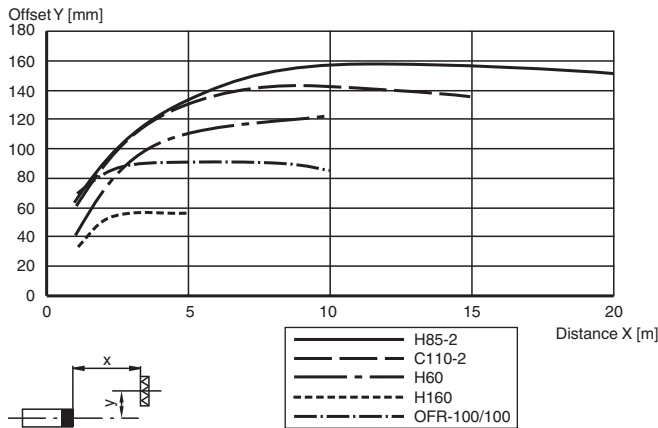

**Relative received light strength**

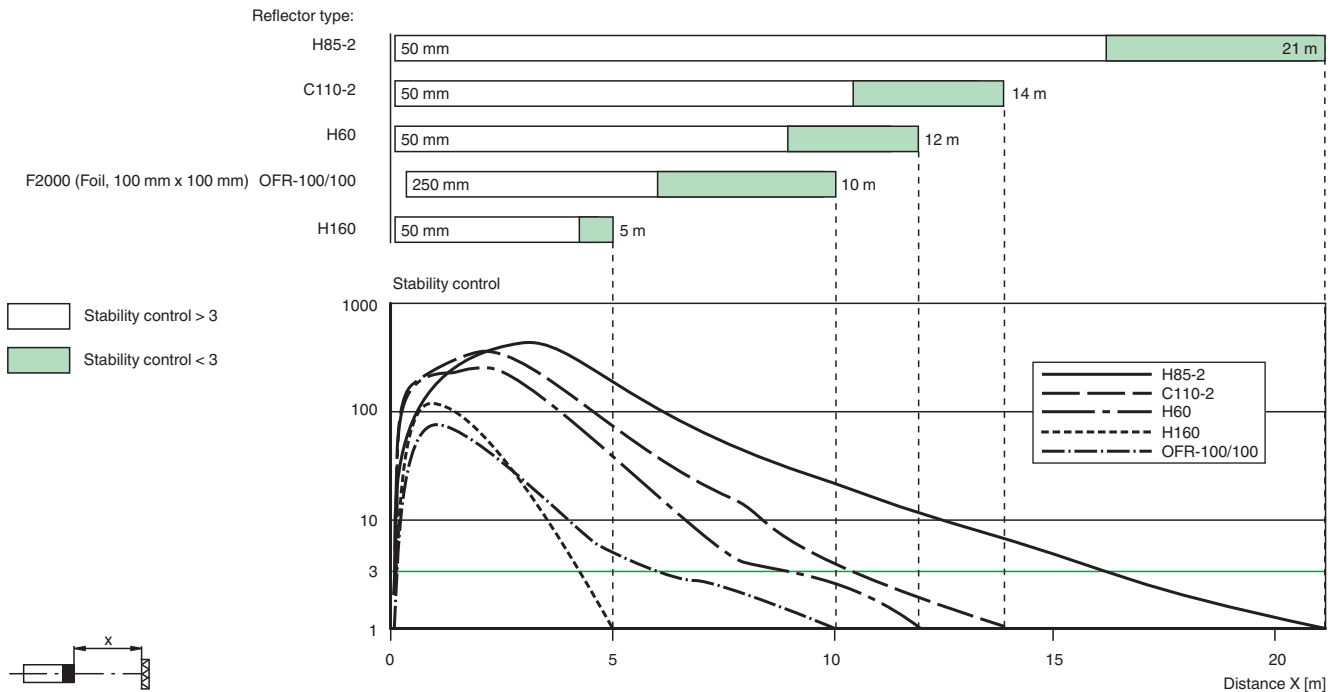





Release date: 2022-10-25 Date of issue: 2022-10-25 Filename: 132450\_eng.pdf

## Application



## Accessories

	<b>OMH-05</b>	Mounting aid for round steel $\varnothing$ 12 mm or sheet 1.5 mm ... 3 mm
	<b>OMH-21</b>	Mounting bracket: mounting aid for sensors in the RL* series
	<b>OMH-22</b>	Mounting aid for RL* series
	<b>OMH-RLK29-HW</b>	Mounting bracket for rear wall mounting
	<b>OMH-RL28-C</b>	Weld slag cover model