

# Standstill and Rotational Direction Monitor

## KFD2-SR2-Ex2.W.SM

- 2-channel isolated barrier
- 24 V DC supply (Power Rail)
- Dry contact or NAMUR inputs
- Selectable frequency trip values
- 2 relay contact outputs
- Start-up override
- Selectable mode of operation
- Line fault detection (LFD)
- Up to SIL 2 acc. to IEC/EN 61508



### Function

This isolated barrier is used for intrinsic safety applications. This device is a standstill monitor that accepts input frequency pulses and triggers an output when the frequency drops below a preselected limit value. Two start-up override values are available. This unit can also be used to determine rotation direction. During an error condition, the relay reverts to its de-energized state and the LEDs indicate the fault according to NAMUR NE 44. The device has LED status indicators for direction of rotation detection, limit detection, supply, and hardware faults. The device is easily configured by the use of DIP switches. If the device is operated via Power Rail, additionally a collective error message is available. For additional information, refer to [www.pepperl-fuchs.com](http://www.pepperl-fuchs.com).

### Connection

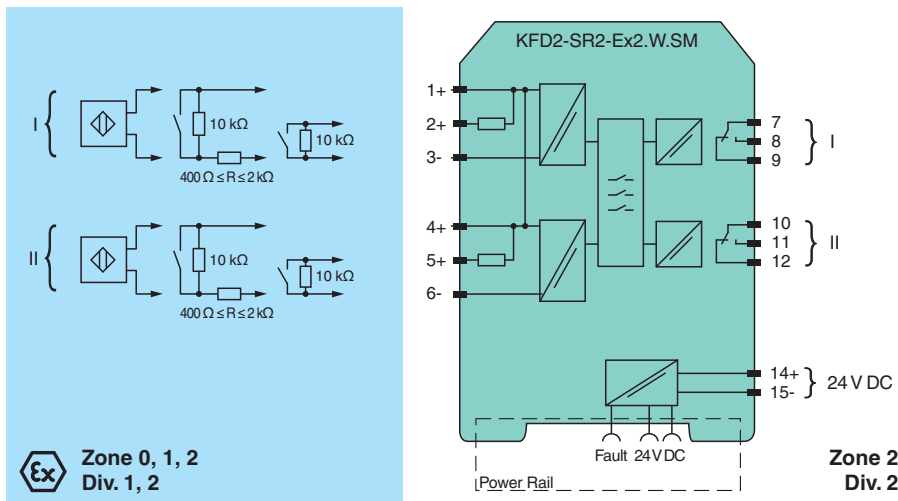

### Technical Data

General specifications	
Signal type	Digital Input
Programming	via DIP switch and programmable
Functional safety related parameters	
Safety Integrity Level (SIL)	SIL 2
Supply	
Connection	Power Rail or terminals 14+, 15-
Rated voltage	$U_r$ 20 ... 30 V DC

Release date: 2022-07-19 Date of issue: 2022-07-19 Filename: 132964\_eng.pdf

## Technical Data

Power consumption		max. 1.5 W
<b>Input</b>		
Connection side		field side
Connection		Input I: terminals 1+, 2+, 3- ; Input II: terminals 4+, 5+, 6-
Rated values		acc. to EN 60947-5-6 (NAMUR)
Open circuit voltage/short-circuit current		approx. 8 V DC / approx. 8 mA
Switching point/switching hysteresis		1.2 ... 2.1 mA / approx. 0.2 mA
Line fault detection		breakage $I \leq 0.1$ mA , short-circuit $I > 6$ mA
Control input		sensor power supply approx. 8.2 V, impedance 1.2 k $\Omega$
Pulse duration		> 200 $\mu$ s for standstill monitoring, > 250 $\mu$ s for rotation direction detection
<b>Output</b>		
Connection side		control side
Connection		output I: terminals 7, 8, 9 ; output II: terminals 10, 11, 12
Contact loading		250 V AC/2 A/cos $\phi > 0.75$ ; 126.5 V AC/4 A/cos $\phi > 0.75$ ; 40 V DC/2 A resistive load
Minimum switch current		2 mA / 24 V DC
Energized/De-energized delay		approx. 20 ms / approx. 20 ms
Mechanical life		10 <sup>7</sup> switching cycles
Trip value	$f_{max}$	for standstill monitoring: 0.1 Hz; 0.5 Hz; 2 Hz; 10 Hz adjustable via DIP switch (S1 and S2)
<b>Transfer characteristics</b>		
Accuracy		5 % (S3 = I), 30 % (S3 = II)
Start-up override		5 seconds or 20 seconds, programmable
Frequency range		$\leq 2$ kHz
Rotation direction detection		90° phase difference between pulse input signal 1 and 2, overlapping $\geq 125$ $\mu$ s
<b>Galvanic isolation</b>		
Input/Output		reinforced insulation according to IEC/EN 61010-1, rated insulation voltage 300 V <sub>eff</sub>
Input/power supply		reinforced insulation according to IEC/EN 61010-1, rated insulation voltage 300 V <sub>eff</sub>
Output/power supply		reinforced insulation according to IEC/EN 61010-1, rated insulation voltage 300 V <sub>eff</sub>
Output/Output		reinforced insulation according to IEC/EN 61010-1, rated insulation voltage 300 V <sub>eff</sub>
<b>Indicators/settings</b>		
Display elements		LEDs
Control elements		DIP switch
Configuration		via DIP switches
Labeling		space for labeling at the front
<b>Directive conformity</b>		
Electromagnetic compatibility		
Directive 2014/30/EU		EN 61326-1:2013 (industrial locations)
Low voltage		
Directive 2014/35/EU		EN 61010-1:2010
<b>Conformity</b>		
Electromagnetic compatibility		NE 21:2006
Degree of protection		IEC 60529:2001
Input		EN 60947-5-6:2000
<b>Ambient conditions</b>		
Ambient temperature		-20 ... 60 °C (-4 ... 140 °F)
<b>Mechanical specifications</b>		
Degree of protection		IP20
Connection		screw terminals
Mass		approx. 150 g
Dimensions		20 x 119 x 115 mm (0.8 x 4.7 x 4.5 inch) (W x H x D) , housing type B2
Mounting		on 35 mm DIN mounting rail acc. to EN 60715:2001

## Technical Data





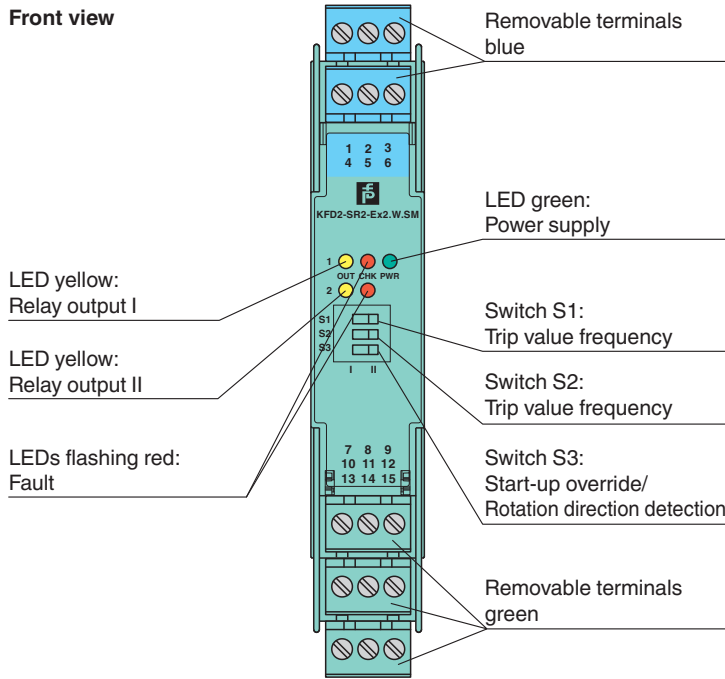

Data for application in connection with hazardous areas		
EU-type examination certificate	PTB 00 ATEX 2080	
Marking	Ⓜ II (1)G [Ex ia Ga] IIC Ⓜ II (1)D [Ex ia Da] IIIC Ⓜ I (M1) [Ex ia Ma] I	
Input	Ex ia	
Voltage	$U_o$	10.5 V
Current	$I_o$	13 mA
Power	$P_o$	34 mW (linear characteristic)
Supply		
Maximum safe voltage	$U_m$	253 V AC / 125 V DC (Attention! $U_m$ is no rated voltage.)
Output		
Maximum safe voltage	$U_m$	253 V AC (Attention! The rated voltage can be lower.)
Fault indication output		
Maximum safe voltage	$U_m$	40 V DC (Attention! $U_m$ is no rated voltage.)
Certificate	TÜV 99 ATEX 1493 X	
Marking	Ⓜ II 3G Ex ec nC IIC T4 Gc	
Output		
Contact loading	50 V AC/4 A/cos $\phi > 0.7$ ; 40 V DC/2 A resistive load	
Galvanic isolation		
Input/Output	safe electrical isolation acc. to IEC/EN 60079-11, voltage peak value 375 V	
Input/power supply	safe electrical isolation acc. to IEC/EN 60079-11, voltage peak value 375 V	
Directive conformity		
Directive 2014/34/EU	EN IEC 60079-0:2018+AC:2020 , EN 60079-7:2015+A1:2018 , EN 60079-11:2012 , EN IEC 60079-15:2019	
International approvals		
FM approval		
FM certificate	FM19US0207X	
Control drawing	116-0035	
UL approval		
Control drawing	E106378	
Control drawing	116-0145	
Contact loading	250 V AC/2 A/cos $\phi > 0.75$ ; 126.5 V AC/4 A/cos $\phi > 0.75$ ; 30 V DC/2 A resistive load	
CSA approval		
Control drawing	116-0047	
IECEx approval		
IECEx certificate	IECEx PTB 11.0034 , IECEx TUN 19.0013X	
IECEx marking	[Ex ia Ga] IIC [Ex ia Da] IIIC [Ex ia Ma] I Ex ec nC IIC T4 Gc	
General information		
Supplementary information	Observe the certificates, declarations of conformity, instruction manuals, and manuals where applicable. For information see <a href="http://www.pepperl-fuchs.com">www.pepperl-fuchs.com</a> .	

## Assembly





Front view



## Matching System Components

	<b>KFD2-EB2</b>	Power Feed Module
	<b>UPR-03</b>	Universal Power Rail with end caps and cover, 3 conductors, length: 2 m
	<b>UPR-03-M</b>	Universal Power Rail with end caps and cover, 3 conductors, length: 1,6 m
	<b>UPR-03-S</b>	Universal Power Rail with end caps and cover, 3 conductors, length: 0.8 m
	<b>K-DUCT-BU</b>	Profile rail, wiring comb field side, blue
	<b>K-DUCT-BU-UPR-03</b>	Profile rail with UPR-03- * insert, 3 conductors, wiring comb field side, blue

## Accessories

	<b>F-NR3-Ex1</b>	NAMUR Resistor Network
	<b>KF-ST-5GN</b>	Terminal block for KF modules, 3-pin screw terminal, green
	<b>KF-ST-5BU</b>	Terminal block for KF modules, 3-pin screw terminal, blue
	<b>KF-CP</b>	Red coding pins, packaging unit: 20 x 6

Release date: 2022-07-19 Date of issue: 2022-07-19 Filename: 132964\_eng.pdf

**Additional Information**

The function of standstill monitor with start-up override (S3 = I) or standstill monitor with rotation direction monitoring (S3 = II) can be selected by means of DIP switches.

S3:	I	II
<b>Function:</b>	Standstill monitor with start-up override	Standstill monitor with rotation direction monitoring
<b>Input I:</b>	Pulse input 1: NAMUR contacts (bounce-free)	Pulse input 1: NAMUR contacts (bounce-free)
<b>Input II:</b>	Start-up override: contact terminal 4 + 6: 20 seconds contact terminal 5 + 6: 5 seconds	Pulse input 2: NAMUR contacts (bounce-free)
<b>Output I:</b>	MIN/passive	MIN/passive
<b>Output II:</b>	MIN/active	Direction of rotation/error

**Standstill monitor with start-up override (S3 = I)**

If the frequency falls below the trip value set with the DIP switches S1 and S2, the standstill monitor with start-up override switches the output I to passive and the output II to active. Input I is used to monitor the frequency of rising current edges. Signal transmitters can be sensors in accordance with EN 60947-5-6 (NAMUR) or contacts. Input I is monitored for lead breakage/short-circuiting. A start-up override can be initiated via input II. The duration of the start-up override can be selected between 5 and 20 seconds by means of a bridge (starting trigger) or an external trigger signal. During the start-up override time the outputs assume the "no standstill" state. In this case there is no lead breakage/short-circuit monitoring at input II.

Trip value	Hysteresis	Switch S2	Switch S1
0.1 Hz	0.02 Hz	I	I
0.5 Hz	0.1 Hz	I	II
2 Hz	0.4 Hz	II	I
10 Hz	2 Hz	II	II

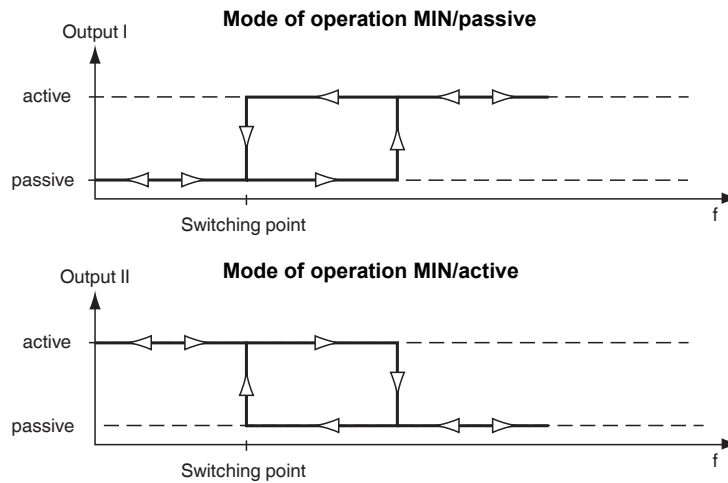

Release date: 2022-07-19 Date of issue: 2022-07-19 Filename: 132964\_eng.pdf

**Standstill monitor with rotation direction monitoring (S3 = II)**

The device also offers stand still monitoring with direction of rotation monitoring as an alternative to stand still monitoring with start-up override. The trip values are identical to the standstill monitor with start-up override. At input II a signal that is offset by 90° to input I has to be applied; in this context minimum signal overlapping should be ensured. Signal transmitters at input I and input II can be sensors in accordance with DIN EN 60947-5-6 (NAMUR) or contacts. Both inputs are monitored for lead faults. Output I is used for standstill signalling and switches to a de-energized state (passive) in the event of a standstill. Output II is switched to active when the direction of rotation is clockwise. If a reverse rotation is detected or if a signal overlap is missing, output II switches to a de-energized state (passive). In this case it can be concluded, that the sensor is misadjusted or defective. If the sensor at input I is misadjusted or defective, input II is used for standstill monitoring.

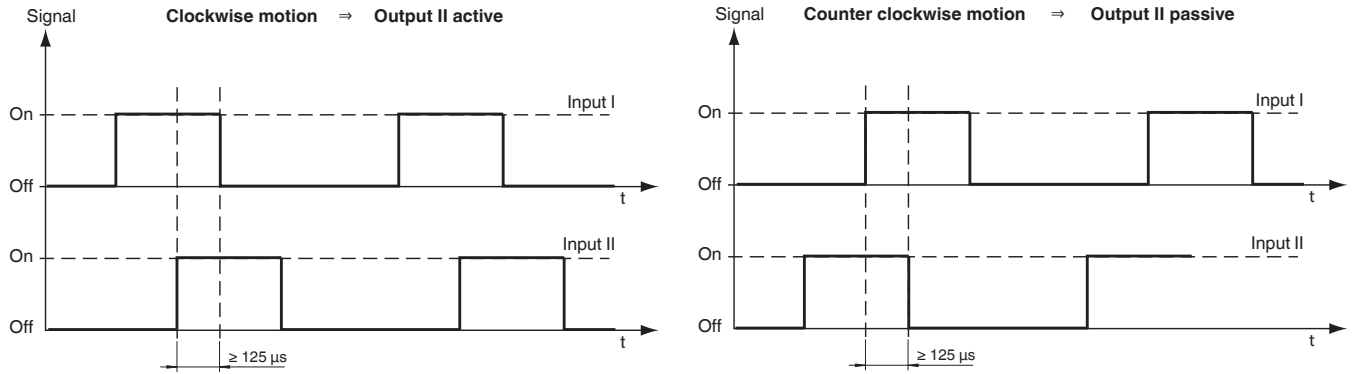

**Behaviour during malfunction:**

- Monitoring for lead faults
- Continuous monitoring of the device for errors in internal memory

If an error occurs, both relays go into the secure state, the red LEDs indicate the error and a collective error message is generated via the Power Rail.

**Advice on use in SIL2 applications (Functional safety)**

Care should be taken to ensure that the relays are de-energized (passive) in the critical condition of the application. Then, in the event of a power failure (de-energized, passive relay) the safety-critical state (energized) relay cannot be achieved.

**Example 1:**

The protective guard for a rotating shaft must remain locked in position until the shaft has stopped rotating. The safety-critical condition is the rotation of the shaft (risk of injury). For this reason, the locking of the protective guard should be achieved by means of a de-energized (passive) relay. The relay shall be energized (active) only when the shaft has stopped (safe condition). This device function is only achieved with "Standstill monitoring with start-up override" (S3 = I) and control of the protective guard with relay 2.

**Example 2:**

The cooling of a critical process by means of fans/coolant pumps has to be monitored. The safety-critical condition is the standstill of the fans/pumps (overheating). For this reason an alarm must be triggered when a relay has de-energized (passive). As long as the fans or the pumps are running (safety condition) the relay is energized (active). This device function can be achieved with "Standstill monitoring with start-up override" (S3 = I) and "Standstill monitoring with direction of rotation signalling" (S3 = II) with relay 1.

**Characteristic Curve**

**Maximum switching power of output contacts**

Release date: 2022-07-19 Date of issue: 2022-07-19 Filename: 132964\_eng.pdf

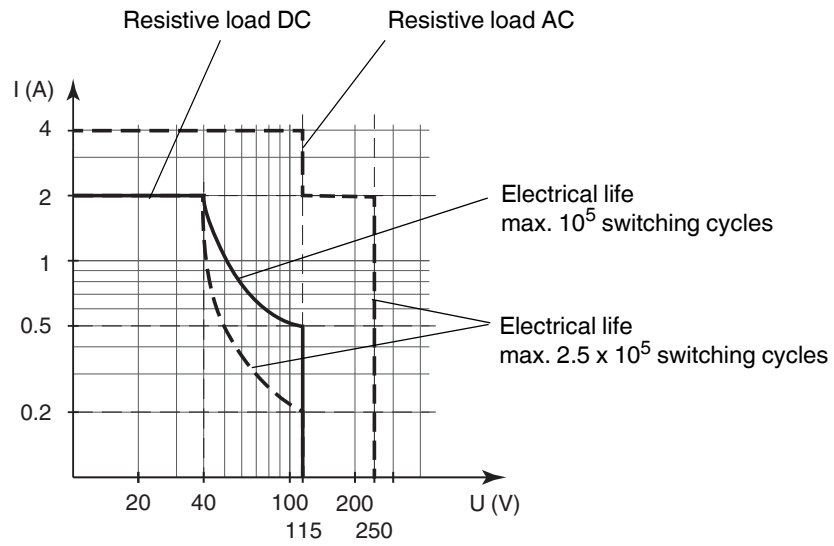

The maximum number of switching cycles is depending on the electrical load and may be higher when reduced currents and voltages are applied.

Release date: 2022-07-19 Date of issue: 2022-07-19 Filename: 132964\_eng.pdf