

Background suppression sensor

RLK28-8-H-2000-IR-Z/31/116

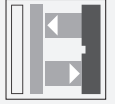

- Universal series with highly versatile fields of use
- Resistant against noise: reliable operation under all conditions
- Minimal black-white difference through the infrared transmission LED
- Programmable time function GAN, GAB, IAB and GAN-IAB as double function
- Version for universal voltages

Background suppression sensor



Dimensions

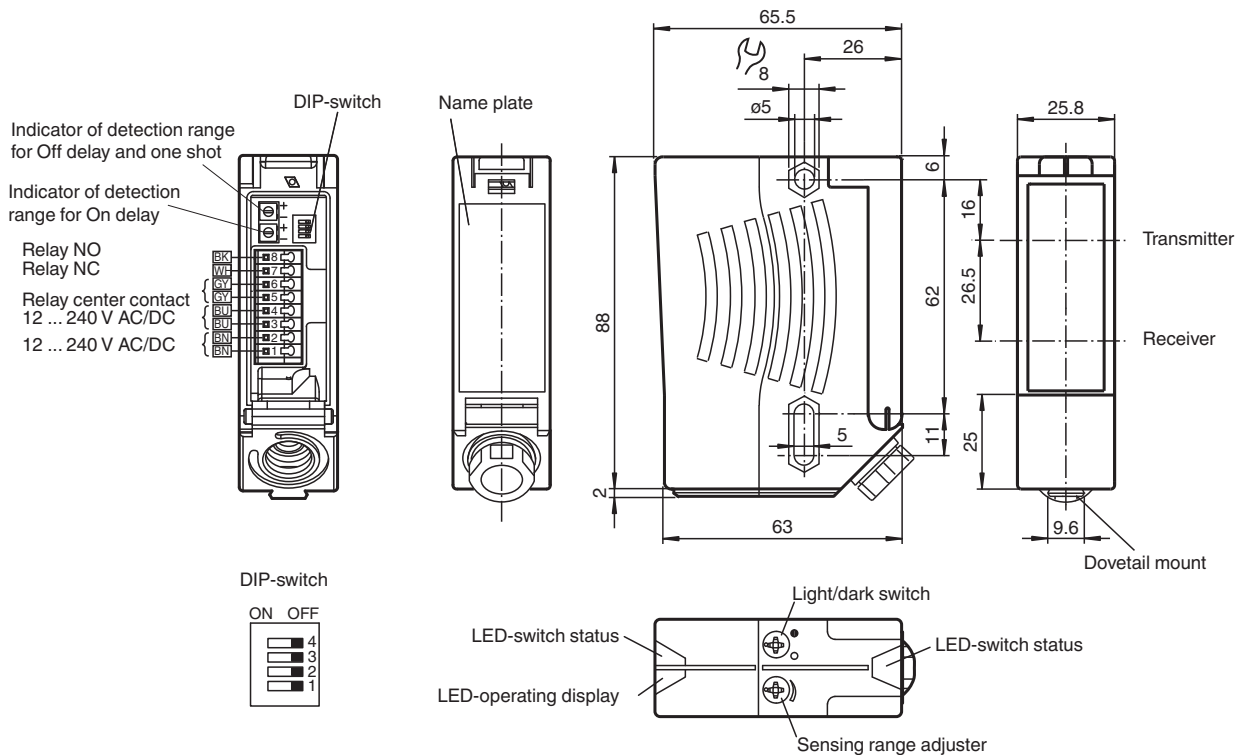

Release date: 2023-04-04 Date of issue: 2023-04-04 Filename: 134133_eng.pdf

Technical Data

General specifications		
Detection range		20 ... 2000 mm
Detection range min.		20 ... 200 mm
Detection range max.		20 ... 2000 mm
Adjustment range		200 ... 2000 mm
Background suppression		max. + 10 % of the upper limit of the detection range
Light source		IREd
Light type		modulated infrared light , 880 nm
Black-white difference (6 %/90 %)		< 40 %
Diameter of the light spot		approx. 70 mm at a distance of 2000 mm
Opening angle		transmitter 2° receiver 2°
Ambient light limit		50000 Lux
Functional safety related parameters		
MTTF _d		620 a
Mission Time (T _M)		20 a
Diagnostic Coverage (DC)		0 %
Indicators/operating means		
Operation indicator		LED green
Function indicator		2 LEDs yellow ON: object inside the scanning range OFF: object outside the scanning range
Control elements		Sensing range adjuster , Light-on/dark-on changeover switch
Electrical specifications		
Operating voltage	U _B	12 ... 240 V AC/DC
Power consumption	P ₀	≤ 3.5 VA
Output		
Switching type		light/dark on, switchable (selectable, light/dark switching is only activated if the receiver has 'dark on' selected.)
Signal output		Relay, 1 alternator
Switching voltage		max. 250 V AC/DC
Switching current		max. 2 A
Switching power		DC: max. 50 W AC: max. 500 VA
Switching frequency	f	25 Hz
Response time		20 ms
Timer function		ON delay (GAN), OFF delay (GAB), one shot (IAB), ON delay-one shot (GAN-IAB), ON delay-OFF delay (GAN-GAB), programmable adjustment interval 0.1 ... 10 s
Conformity		
Product standard		EN 60947-5-2
Approvals and certificates		
Protection class		II, rated insulation voltage ≤ 250 V AC with pollution degree 1-2 according to IEC 60664-1 Output circuit insulated from control circuit in accordance with IEC 61140. Caution! The protection class 2 is only valid when the terminal compartment is closed.
UL approval		E87056 , cULus Listed Caution: This equipment is considered as open-type equipment. It must be mounted within an enclosure, that is suitably designed for protection against internal fire and personal injury resulting from accessibility to live parts according UL 508.
CCC approval		Certified by China Compulsory Certification (CCC)
Ambient conditions		
Ambient temperature		-40 ... 60 °C (-40 ... 140 °F)
Storage temperature		-40 ... 60 °C (-40 ... 140 °F)
Mechanical specifications		
Housing width		25.8 mm
Housing height		88 mm
Housing depth		65.5 mm

Technical Data

Degree of protection	IP67
Connection	terminal compartment with 8 spring-loaded terminals for wire cross section 0.5 ... 1.5 mm ² , insulation stripping 7.5 ... 8.5 mm, M16 x 1.5 cable gland
Material	
Housing	Plastic ABS
Optical face	Plastic pane
Mass	112 g

Connection Assignment

Option:

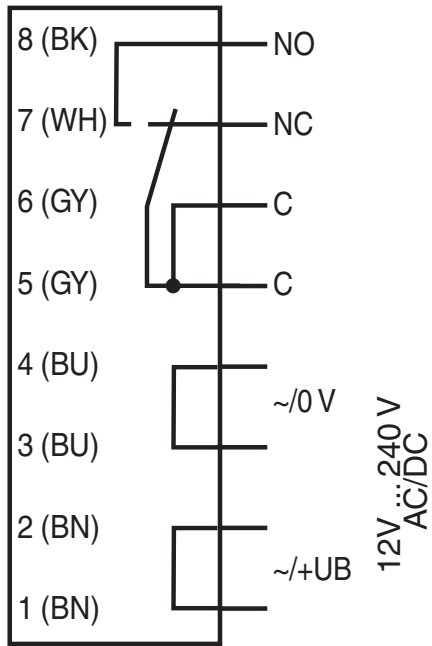

The relay-functions "NC" and "NO" bear on the switching mode "Light-ON". This complies to the default setting of the light/dark switch, located on top of the housing (factory setting).

Characteristic Curve

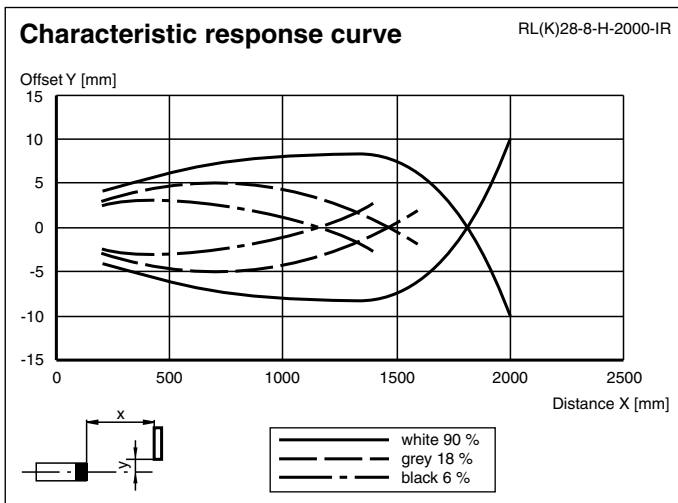



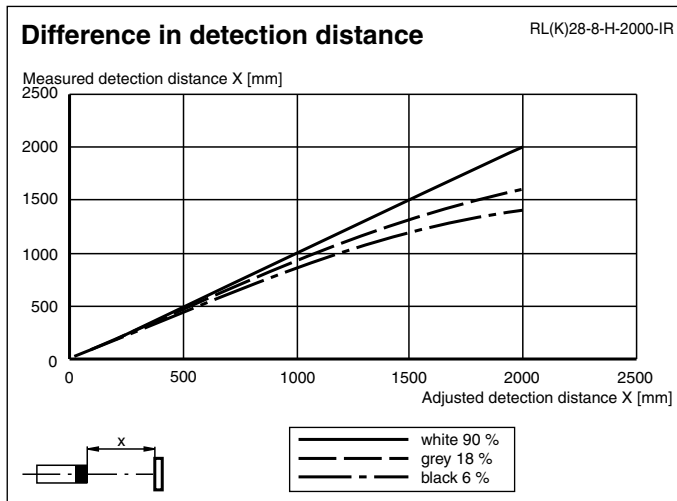

Release date: 2023-04-04 Date of issue: 2023-04-04 Filename: 134133_eng.pdf

Characteristic Curve



Accessories

	OMH-05	Mounting aid for round steel \varnothing 12 mm or sheet 1.5 mm ... 3 mm
	OMH-21	Mounting bracket: mounting aid for sensors in the RL* series
	OMH-22	Mounting aid for RL* series
	OMH-RLK29	Mounting bracket
	OMH-RLK29-HW	Mounting bracket for rear wall mounting

Timer functions

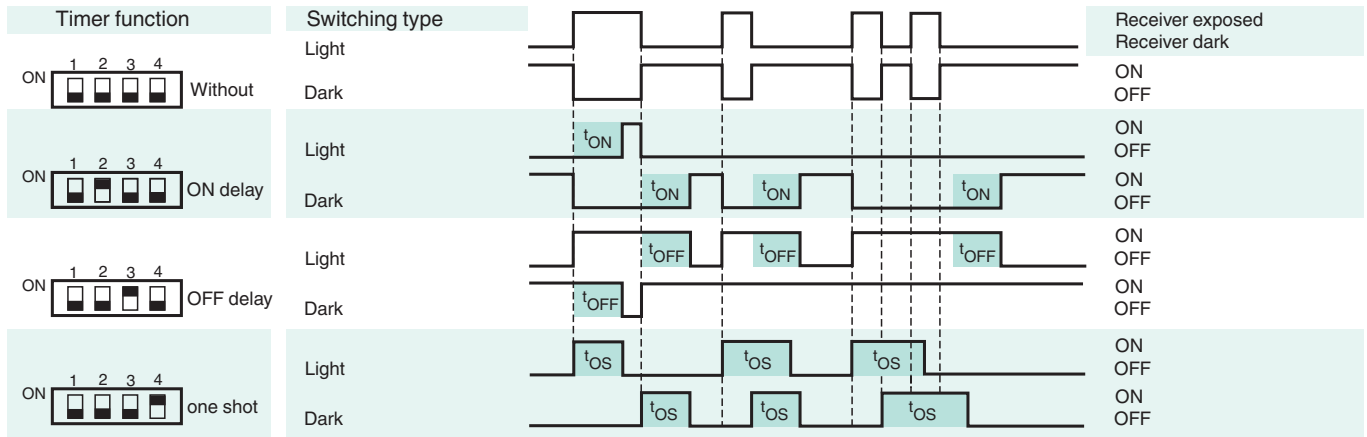

Time t_{ON} , t_{OFF} and t_{OS} are adjustable from 0.1 to 10 seconds.
 The Light-/Dark-Switch (Left, outer switch) is shown in the "Dark ON" position.

Type	Description	Notes
-Z	OFF delay timer	Adjustable time interval (0.1 s - 10 s)
	one shot timer	
	ON delay timer	
	ON delay timer / OFF delay timer	
	ON delay timer / one shot timer	