



# Background suppression sensor RL28-8-H-700-RT-3019/47/115b



- Ultra bright LEDs for power on and switching state
- Good alignability due to red transmission LED
- Not sensitive to ambient light, even with switched energy saving lamps
- Waterproof, degree of protection IP67
- Protection class II

Background suppression sensor



## Dimensions

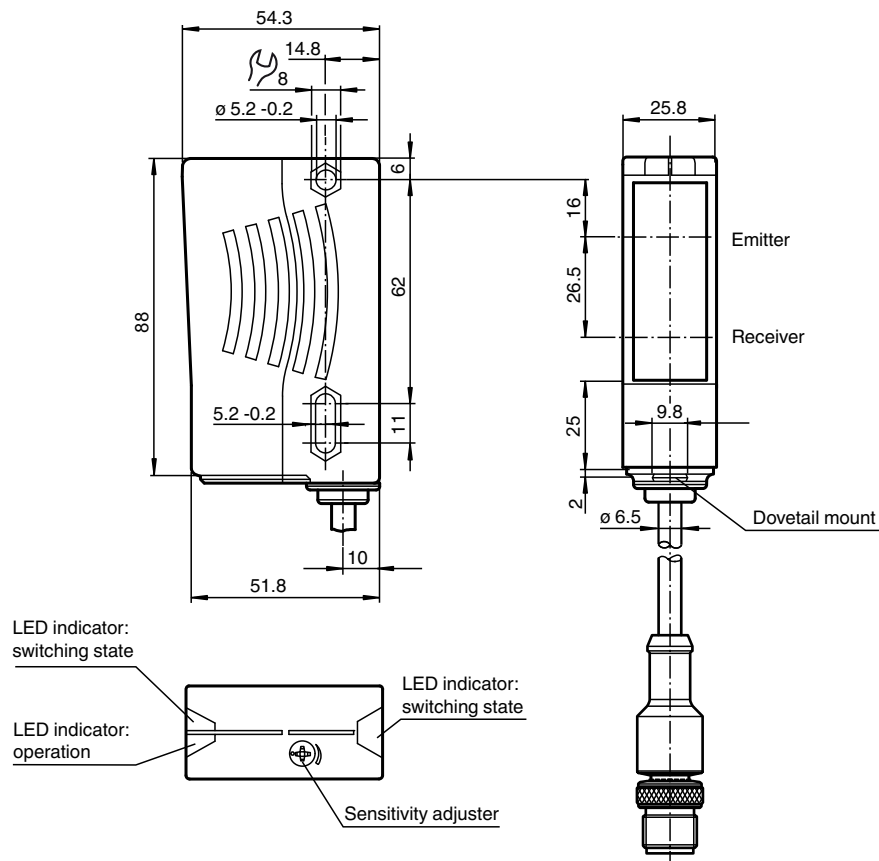

## Technical Data

### General specifications

Detection range	20 ... 700 mm
Detection range min.	20 ... 200 mm

Release date: 2023-04-04 Date of issue: 2023-04-04 Filename: 180710\_eng.pdf

## Technical Data

Detection range max.	20 ... 700 mm	
Background suppression	max. + 10 % of the upper limit of the detection range	
Light source	LED	
Light type	modulated visible red light , 660 nm	
Black-white difference (6 %/90 %)	< 20 %	
Diameter of the light spot	approx. 15 mm at a distance of 700 mm	
Opening angle	Emitter 1.2° Receiver 2°	
Ambient light limit	50000 Lux	
<b>Functional safety related parameters</b>		
MTTF <sub>d</sub>	720 a	
Mission Time (T <sub>M</sub> )	20 a	
Diagnostic Coverage (DC)	0 %	
<b>Indicators/operating means</b>		
Operation indicator	LED green	
Function indicator	2 LEDs yellow ON: object inside the scanning range OFF: object outside the scanning range	
Control elements	Sensing range adjuster	
<b>Electrical specifications</b>		
Operating voltage	U <sub>B</sub>	10 ... 30 V DC
Ripple	10 %	
No-load supply current	I <sub>0</sub>	≤ 40 mA
<b>Output</b>		
Switching type	light/dark on	
Signal output	2 PNP, complementary, short-circuit protected, reverse polarity protected , open collectors	
Switching voltage	max. 30 V DC	
Switching current	max. 200 mA	
Switching frequency	f	250 Hz
Response time	2 ms	
<b>Conformity</b>		
Product standard	EN 60947-5-2	
<b>Approvals and certificates</b>		
Protection class	II, rated voltage ≤ 250 V AC with pollution degree 1-2 according to IEC 60664-1	
UL approval	E87056 , cULus Listed , class 2 power supply , type rating 1	
<b>Ambient conditions</b>		
Ambient temperature	-40 ... 60 °C (-40 ... 140 °F)	
Storage temperature	-40 ... 60 °C (-40 ... 140 °F)	
<b>Mechanical specifications</b>		
Housing width	25.8 mm	
Housing height	88 mm	
Housing depth	54.3 mm	
Degree of protection	IP67	
Connection	0.2 m fixed cable with 4-pin, M12 connector	
Material		
Housing	Plastic ABS	
Optical face	plastic	
Mass	70 g	

**Connection**

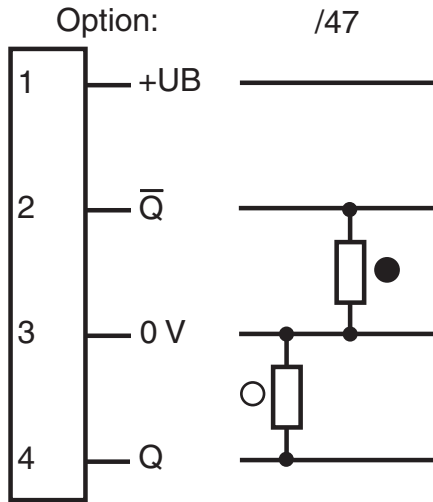

○ = Light on  
● = Dark on

**Connection Assignment**

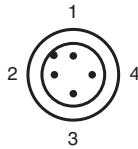

Wire colors in accordance with EN 60947-5-2

1	BN	(brown)
2	WH	(white)
3	BU	(blue)
4	BK	(black)

**Characteristic Curve**

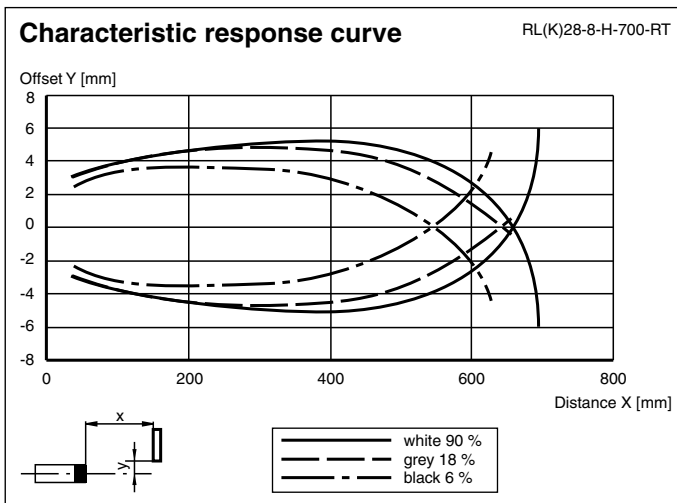

Release date: 2023-04-04 Date of issue: 2023-04-04 Filename: 180710\_eng.pdf



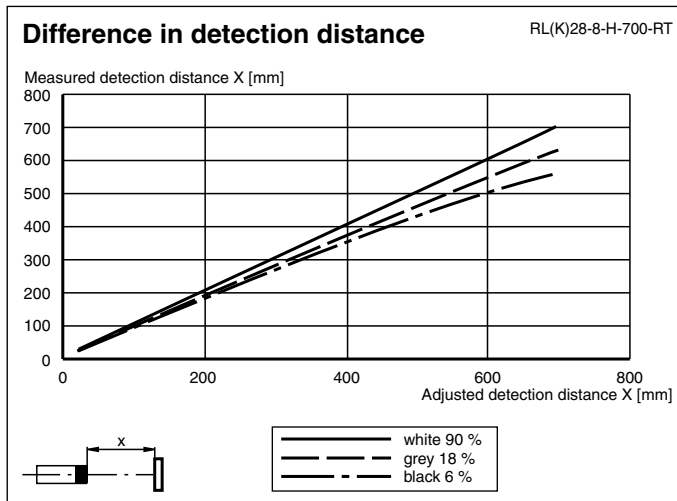

## Characteristic Curve



## Application



## Accessories

	<b>OMH-05</b>	Mounting aid for round steel $\varnothing$ 12 mm or sheet 1.5 mm ... 3 mm
	<b>OMH-21</b>	Mounting bracket: mounting aid for sensors in the RL* series
	<b>OMH-22</b>	Mounting aid for RL* series
	<b>OMH-RLK29-HW</b>	Mounting bracket for rear wall mounting
	<b>OMH-RL28-C</b>	Weld slag cover model

**Additional information****Intended use:**

The transmitter and receiver are located in the same housing for direct detection sensors with background masking. Marking of objects outside the detection range is achieved by arranging the angle between the transmitter and receiver (2 receiver elements).

Objects are detected independently of their surface structures, brightness and colour, as well as the brightness of the background.

**Mounting instructions:**

The sensors can be fastened directly with fixing screws or with a support bracket (not included with delivery).

The surface underneath must be flat to prevent the housing from moving when it is tightened into position. We recommend securing the nut and screw in place with spring washers to prevent the sensor from going out of adjustment.

**Adjustment:**

After the operating voltage is applied, the LED is lit green.

Align the sensor to the background. If the yellow LED is lit, the detection range should be reduced with the detection range adjuster until the yellow LED goes out.

**Object direction:**

Place the object to be detected at the desired maximum detection range and align the light spot to it. If the object is detected, the yellow LED lights up.

If it does not light up, the detection range must be adjusted on the potentiometer until it lights up when an object is detected.

**Cleaning:**

We recommend cleaning the optical surface and checking the screwed connection and other connections at regular intervals.