



RFID Transponder

IPC03-58

- Battery-free data carrier
- 32 bit fixcode
- 928 bits memory available
- Degree of protection IP67
- Mounting holes for simple installation
- High resistance against water, chemicals, transformer oil, petrol and heating oil

Data carrier



Dimensions

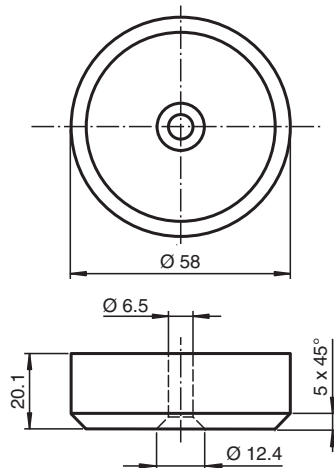

Technical Data

General specifications	
Operating frequency	125 kHz
Transfer rate	2 kBit/s
Memory	
Chip Type	EM4450 Titan (EM Microelectronic)
EEPROM	928 Bit
Read cycles	unlimited
Write cycles	> 100000
Data retention period	10 years at 55 °C (131 °F)
Directive conformity	
Radio equipment	
Directive 2014/53/EU	EN 300330
RoHS	
Directive 2011/65/EU (RoHS)	IEC/EN 63000
Standard conformity	
Degree of protection	EN 60529
RFID	ISO/IEC 18000-2

Release date: 2024-06-18 Date of issue: 2024-06-18 Filename: 182162_eng.pdf

Technical Data

Ambient conditions

Ambient temperature	-25 ... 85 °C (-13 ... 185 °F)
Storage temperature	-25 ... 120 °C (-13 ... 248 °F)

Mechanical specifications

Degree of protection	IP67
Material	
Housing	PA 6 (Polyamide)
Encapsulation compound	Polyurethane (PUR)
Installation	
On metal	yes
In air	yes
Dimensions	
Height	20.1 mm
Diameter	58 mm
Construction type	Cylindrical

Reading range in air IPC03-58

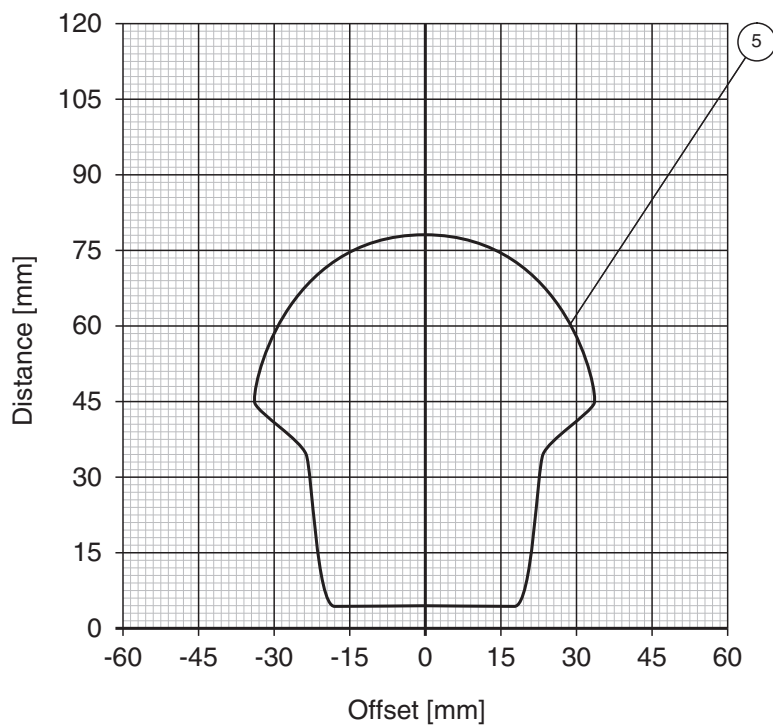

Writing range in air IPC03-58

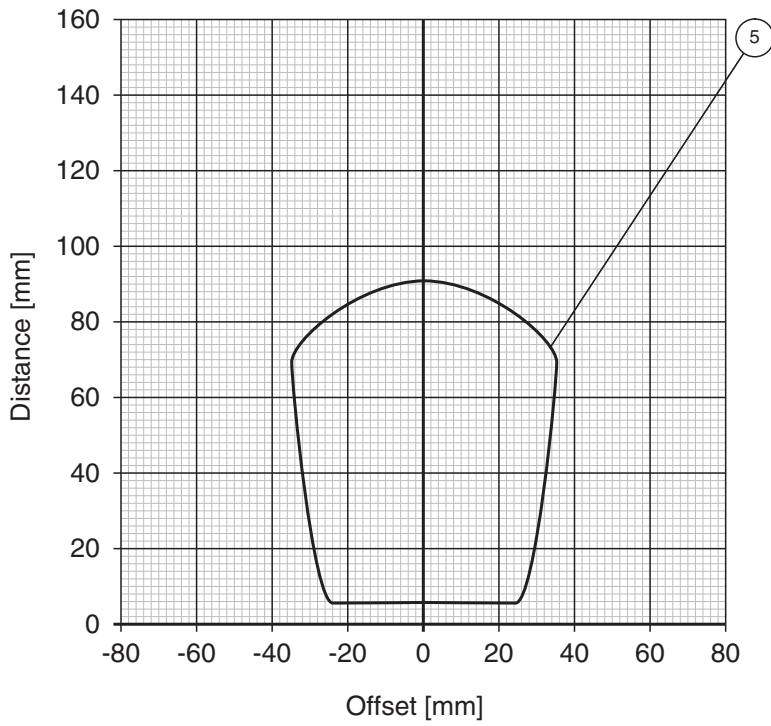

Release date: 2024-06-18 Date of issue: 2024-06-18 Filename: 182162_eng.pdf

Reading range on aluminium IPC03-58

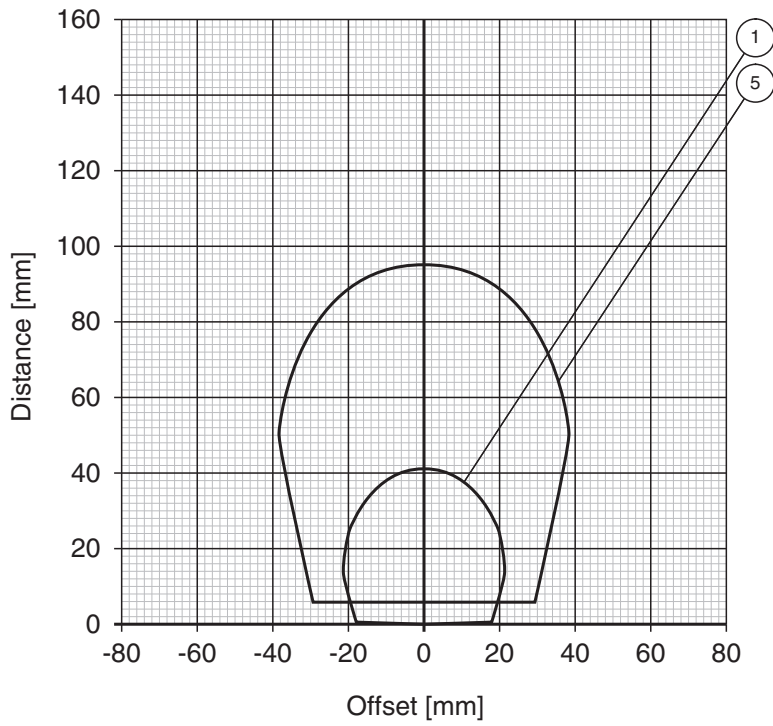

Release date: 2024-06-18 Date of issue: 2024-06-18 Filename: 182162_eng.pdf

Writing range on aluminium IPC03-58

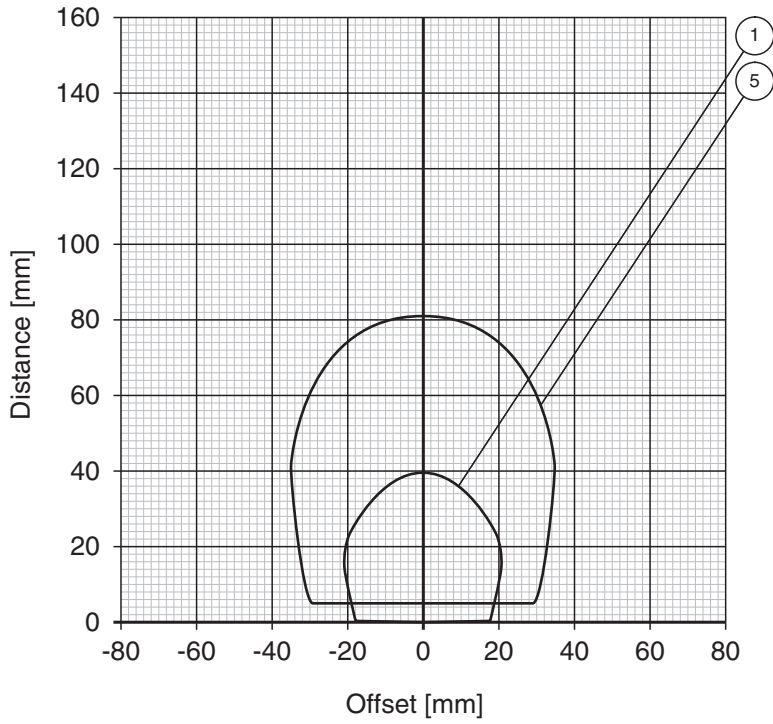

Release date: 2024-06-18 Date of issue: 2024-06-18 Filename: 182162_eng.pdf

Reading range on steel IPC03-58

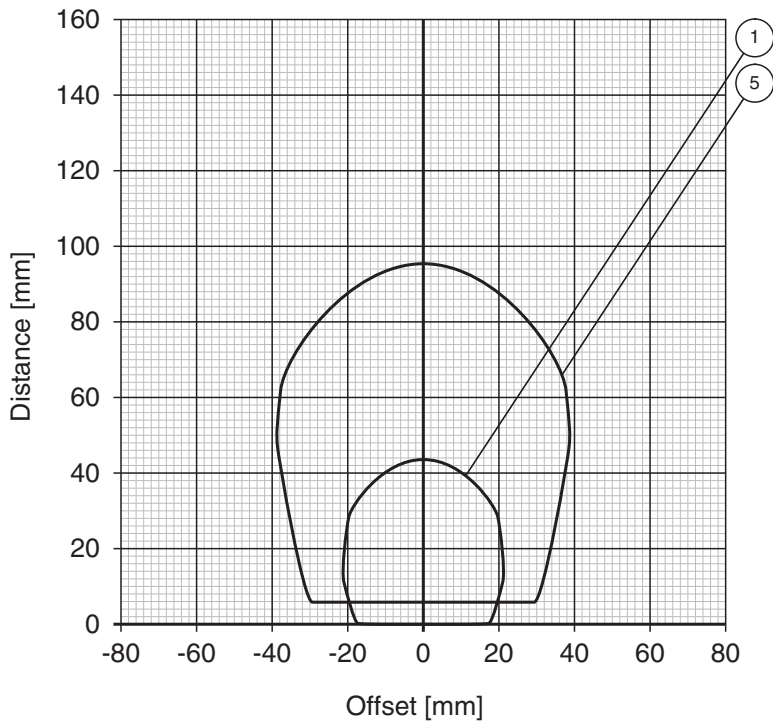

Release date: 2024-06-18 Date of issue: 2024-06-18 Filename: 182162_eng.pdf

Writing range on steel IPC03-58

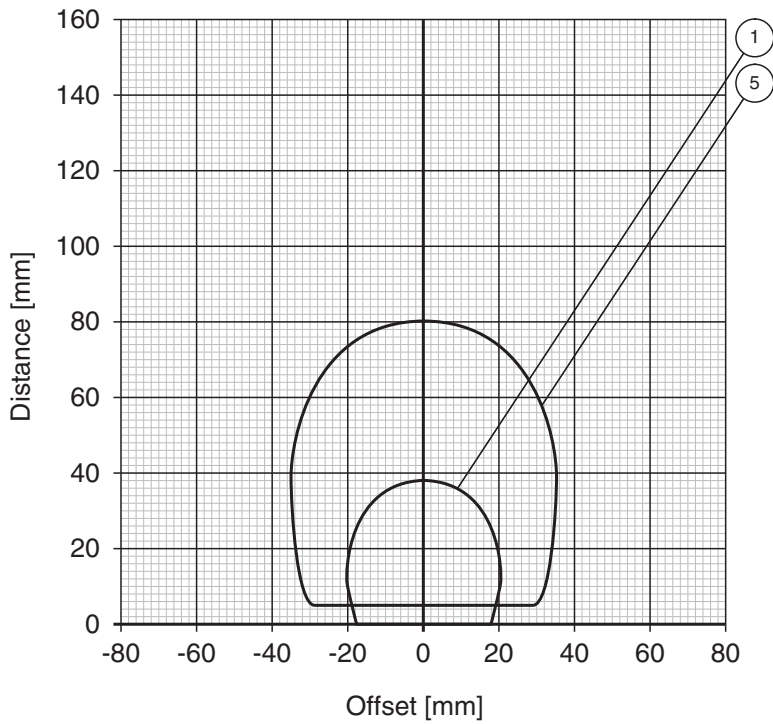

- ① IPH-18GM-V1
- ③ IPH-F61
- ⑤ IPH-FP-V1
- ⑦ IPT1-FP-V1
- ② IPH-30GM-V1
- ④ IPH-L2-V1
- ⑥ IPH-F15-V1

Release date: 2024-06-18 Date of issue: 2024-06-18 Filename: 182162_eng.pdf

Mounting

The surface containing the text must face the read/write head.