



Retroreflective sensor

MLV41-54-G/25/70/123/136



- Rugged series in corrosion-resistant metal housing
- Reliable recognition of reflective objects and clear glass
- Two machines in one: clear object detection or reflection operating mode with long range
- TEACH-IN switch for setting the contrast detection levels
- Automatic adjustment in case of soiling in contrast detection mode
- Resistant against noise: reliable operation under all conditions

Robust retroreflective sensor for glass detection, compact housing design, 5.2 m detection range, red light, light on, 2 push-pull outputs, M9 plug



Function

The unique and extremely popular design of the MLV41 series enables it be mounted correctly in confined areas and offers all the functions that are normally only found on larger photoelectric sensors. The MLV41 series comes with a range of functions. For example, highly visible status LEDs on the front and back, resistance to ambient light, crosstalk protection and universally applicable output stages that permit every possible switching logic and polarity to be realized. The enhanced resistance to ambient light ensures reliable operation even where modern energy-saving lamps with electronic ballasts are in use. The same applies where multiple devices are present, i.e. the use of a number of sensors in the same vicinity causes no problems.

Dimensions

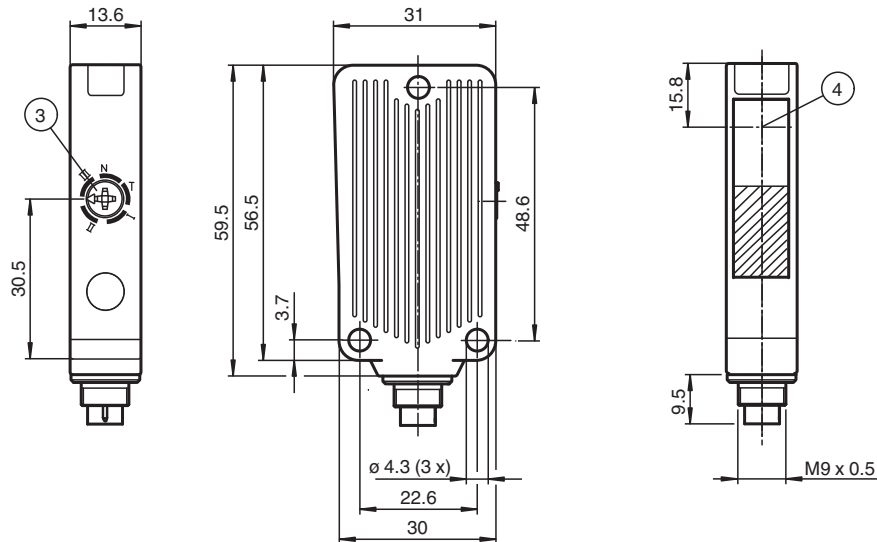

Technical Data

| General specifications | |
|--------------------------------------|--|
| Effective detection range | 0 ... 4 m in TEACH mode 0 ... 5.2 m at switch position "N" |
| Reflector distance | 0 ... 4 m in TEACH mode 0 ... 5.2 m at switch position "N" |
| Threshold detection range | 6.5 m |
| Reference target | H85-2 reflector |
| Light source | LED |
| Light type | modulated visible red light , 660 nm |
| Polarization filter | yes |
| Angle deviation | max. $\pm 1^\circ$ |
| Diameter of the light spot | approx. 100 mm at detection range 4 m |
| Opening angle | 1.5 ° |
| Ambient light limit | 40000 Lux |
| Functional safety related parameters | |
| MTTF _d | 900 a |
| Mission Time (T _M) | 20 a |
| Diagnostic Coverage (DC) | 0 % |
| Indicators/operating means | |
| Operation indicator | LED green, statically lit Power on , Undervoltage indicator: Green LED, pulsing (approx. 0.8 Hz) , short-circuit : LED green flashing (approx. 4 Hz) |
| Function indicator | 2 LEDs yellow for switching state, stability control, TEACH-IN and contrast detection mode |

Technical Data

| | | |
|-----------------------------------|--|---|
| Control elements | 5-step switch for setting the contrast detection levels. | |
| Contrast detection levels | | 10 % - clean, water filled PET bottles 18 % - clear glass bottles 40 % - colored glass or opaque materials adjustable due to Teach-In switch |
| Electrical specifications | | |
| Operating voltage | U_B | 10 ... 30 V DC |
| Ripple | | max. 10 % |
| No-load supply current | I_0 | max. 35 mA |
| Input | | |
| Function input | | Ext. Teach-In input (ET) |
| Output | | |
| Signal output | | 2 push-pull (4 in 1) outputs, complementary, short-circuit proof, reverse polarity protected |
| Switching voltage | | max. 30 V DC |
| Switching current | | max. 100 mA |
| Voltage drop | U_d | ≤ 2.5 V DC |
| Switching frequency | f | 1000 Hz |
| Response time | | 0.5 ms |
| Conformity | | |
| Product standard | | EN 60947-5-2 |
| Approvals and certificates | | |
| UL approval | | cULus Listed 57M3 (Only in association with UL Class 2 power supply; Type 1 enclosure) |
| CCC approval | | CCC approval / marking not required for products rated ≤ 36 V |
| Ambient conditions | | |
| Ambient temperature | | -40 ... 60 °C (-40 ... 140 °F) |
| Storage temperature | | -40 ... 75 °C (-40 ... 167 °F) |
| Mechanical specifications | | |
| Housing width | | 31 mm |
| Housing height | | 56.5 mm |
| Housing depth | | 13.6 mm |
| Degree of protection | | IP67 |
| Connection | | with M9, 5-pin metal connector |
| Material | | |
| Housing | | Aluminum , Delta-Seal coated |
| Optical face | | glass pane |
| Connector | | metal |
| Mass | | 50 g |

Connection Assignment

Option:

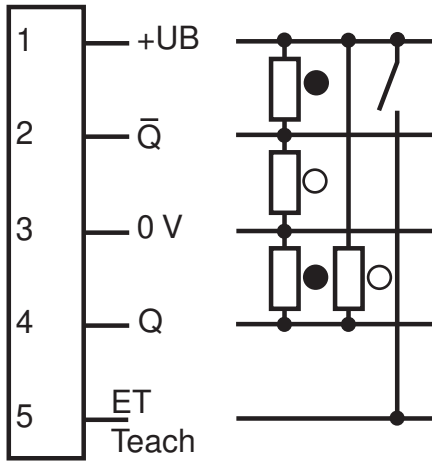

Note:

In the case of replacements for MLV40, the differing pin assignment (EURO standard) must be taken into account

- = Light on
- = Dark on

Connection Assignment

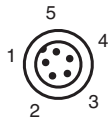

Wire colors in accordance with EN 60947-5-2

- 1 | BN (brown)
- 2 | WH (white)
- 3 | BU (blue)
- 4 | BK (black)
- 5 | GY (gray)

Assembly

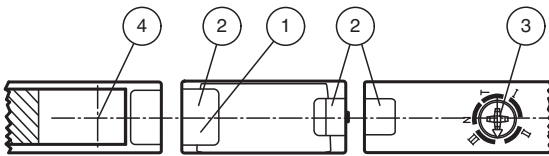



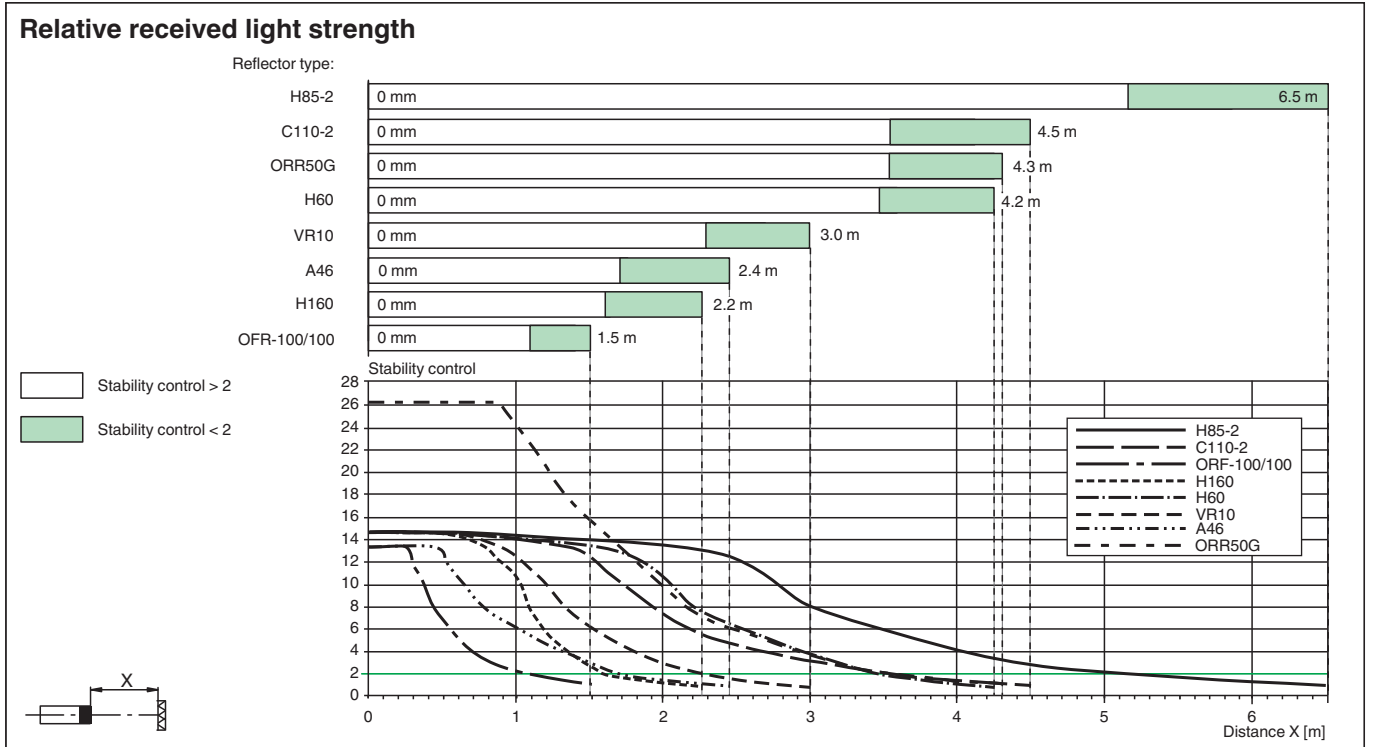
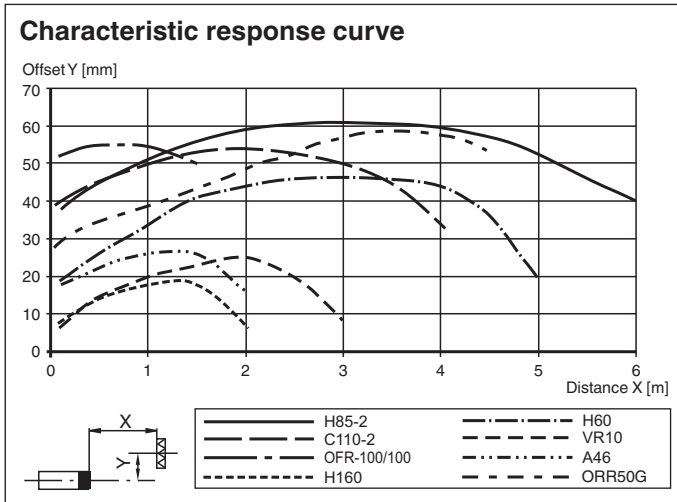

| | | |
|---|-------------------------------------|--------|
| 1 | Operating display | green |
| 2 | Functional display | yellow |
| 3 | Teach-In switch | |
| 4 | Optical center emitter and receiver | |

Release date: 2023-03-28 Date of issue: 2023-03-28 Filename: 183621_eng.pdf

Characteristic Curve





Accessories

| | | |
|---|------------------|--|
|  | OMH-09 | Mounting bracket for Sensors series MLV41 for M12 rod mounting |
|  | OMH-40 | Mounting bracket |
|  | REF-H85-2 | Reflector, rectangular 84.5 mm x 84.5 mm, mounting holes |
|  | REF-H50 | Reflector, rectangular 51 mm x 61 mm, mounting holes, fixing strap |
|  | REF-VR10 | Reflector, rectangular 60 mm x 19 mm, mounting holes |

Release date: 2023-03-28 Date of issue: 2023-03-28 Filename: 183621_eng.pdf

Accessories

| | | |
|---|--------------------|--|
|  | ORR50G | Reflector, rectangular 50.9 mm x 60.9 mm, mounting holes, fixing strap and polarization filter |
|  | OFR-100/100 | Reflective tape 100 mm x 100 mm |

Teach-In

Instructions for the Teach-In mode:

| Step | Switch position | LED green | LED yellow | Time/ Frequency | Explanations/ Remarks |
|------|-----------------|-----------|------------|-----------------|---|
| 1 | N | on | flashes | 4/s | In switch position "N" aligned with reflector. Reflector detected without functional reserve . |
| | N | on | on | - | In switch position "N" aligned with reflector. Reflector detected with functional reserve (recommended). |
| 2 | T | off/on | on | 200 ms | A new switch position is indicated by the green LED going out briefly. This applies also for the selection of the other switch positions. |
| | T | flashes | flashes | 2.5/s | <i>Slow</i> alternating flashing: Teach-In process correctly executed. Max. duration of the Teach-In process: 2 s |
| | T | flashes | flashes | 8/s | <i>Rapid</i> alternating flashing: Teach-In process not correctly executed. (e.g. receiver signal not sufficient, sensor not correctly aligned with reflector). Status is terminated by turning switch to position N. |
| 3/1 | I | on | on | - | Contrast detection 10 % is activated. (e.g. clean PET bottles filled with water) |
| 3/2 | II | on | on | - | Contrast detection 18 % is activated. (e.g. bottles made of clear glass) |
| 3/3 | III | on | on | - | Contrast detection 40 % is activated. (e.g. tinted glass or intransparent materials) |

Ext. TEACH input:

In switch position "T" it is possible to trigger a Teach-In process and to select the corresponding contrast detection level by the external application of a High pulse of a certain width:

| | |
|-------------|------------------|
| I: 50 ms | (30 ... 80 ms) |
| II: 150 ms | (120 ... 180 ms) |
| III: 250 ms | (220 ... 280 ms) |
| N: 350 ms | (320 ... 380 ms) |