



Retroreflective sensor RL31-54/25/73c/136



- Compact and stable housing
- Glare protected with polarization filter
- Highly visible LED
- Powerful push-pull output
- Protection class II

Retroreflective sensor with polarization filter, plastic housing, 9 m detection range, red light, light on, DC version, 2 push-pull outputs, no control elements, M12 plug



Dimensions

Operating principle	color
Retroreflective sensor with polarisation filter	green
Retroreflective sensor	blue
Diffusive mode sensor	white
Thru-beam sensor	grey
Diffusive mode sensor with background suppression	red

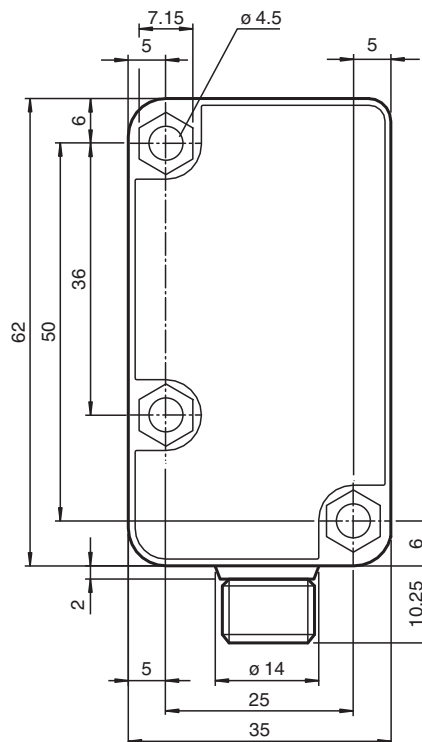
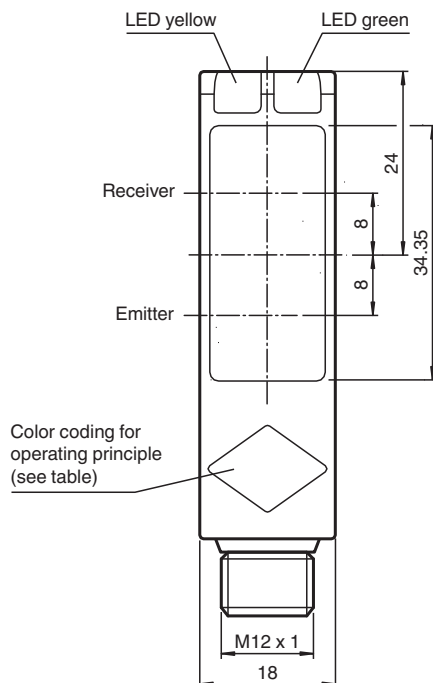
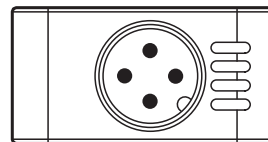

Technical Data

General specifications

Effective detection range 0 ... 9000 mm

Release date: 2023-10-13 Date of issue: 2023-10-13 Filename: 183810_eng.pdf

Technical Data

Reflector distance		20 ... 9000 mm
Threshold detection range		12 m
Reference target		reflector C110-2
Light source		LED
Light type		modulated visible red light , 630 nm
Polarization filter		yes
Diameter of the light spot		approx. 200 mm at a distance of 6 m
Opening angle		3 °
Ambient light limit		50000 Lux ; according to EN 60947-5-2
Functional safety related parameters		
MTTF _d		920 a
Mission Time (T _M)		20 a
Diagnostic Coverage (DC)		0 %
Indicators/operating means		
Operation indicator		LED green: power on
Function indicator		LED yellow: 1. LED lit constantly: signal > 2 x switching point (function reserve) 2. LED flashes: signal between 1 x switching point and 2 x switching point 3. LED off: signal < switching point
Electrical specifications		
Operating voltage	U _B	10 ... 30 V DC
Ripple		10 %
No-load supply current	I ₀	≤ 20 mA
Output		
Switching type		light-on
Signal output		2 push-pull (4 in 1) outputs, short-circuit protected, reverse polarity protected
Switching voltage		max. 30 V DC
Switching current		max. 100 mA
Voltage drop	U _d	≤ 1.5 V
Switching frequency	f	≤ 500 Hz
Response time		≤ 1 ms
Conformity		
Product standard		EN 60947-5-2
Approvals and certificates		
Protection class		II , rated insulation voltage ≤ 250 V AC with pollution degree 1-2 according to IEC 60664-1 Output circuit basis insulation of input circuit according to EN 50178, rated insulation voltage 240 V AC
UL approval		cULus Listed, Class 2 Power Source, Type 1 enclosure
CCC approval		CCC approval / marking not required for products rated ≤36 V
Ambient conditions		
Ambient temperature		-30 ... 55 °C (-22 ... 131 °F)
Storage temperature		-40 ... 70 °C (-40 ... 158 °F)
Mechanical specifications		
Housing width		18 mm
Housing height		62 mm
Housing depth		35 mm
Degree of protection		IP67
Connection		4-pin, M12 x 1 connector
Material		
Housing		plastic
Optical face		PMMA
Mass		24 g

Connection Assignment

Option:

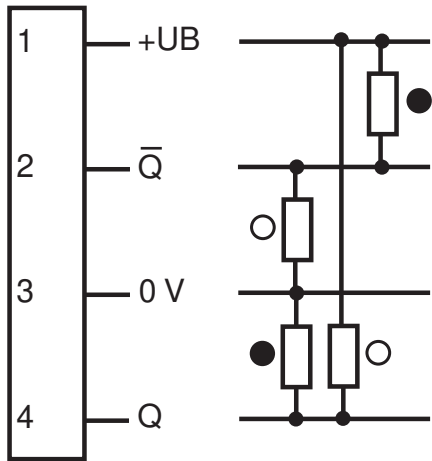

○ = Light on
● = Dark on

Connection Assignment

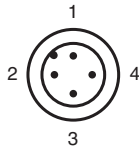

Wire colors in accordance with EN 60947-5-2

- 1 | BN (brown)
- 2 | WH (white)
- 3 | BU (blue)
- 4 | BK (black)

Assembly

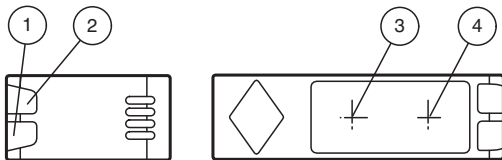

1	Operating display	green
2	Signal display	yellow
3	Emitter	
4	Receiver	

Release date: 2023-10-13 Date of issue: 2023-10-13 Filename: 183810_eng.pdf

Characteristic Curve

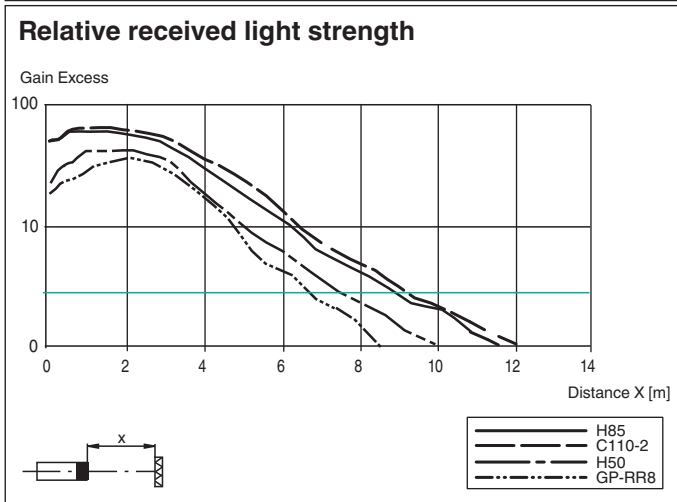
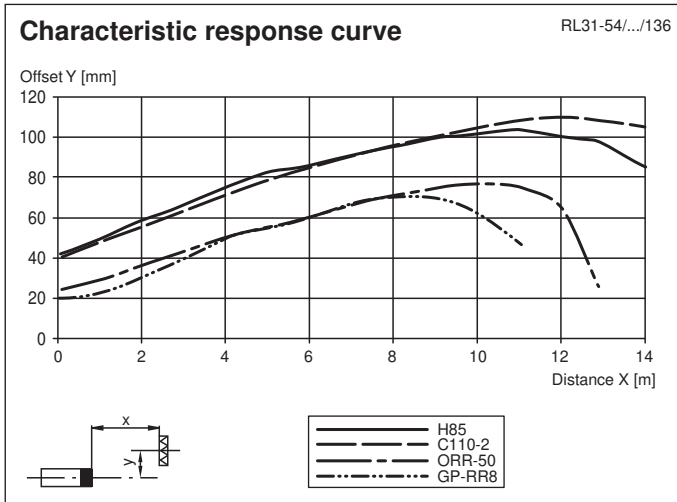

Accessories

	OMH-RL31-01	Mounting bracket
	OMH-RL31-02	Mounting bracket narrow
	OMH-RL31-03	Mounting bracket narrow
	OMH-RL31-04	Mounting aid for round steel \varnothing 12 mm or sheet 1.5 mm ... 3 mm
	OMH-RL31-05	Mounting bracket for mounting on flat surfaces with 2 M4 screws
	OMH-RL31-06	Stainless steel mounting bracket with adjustable half clamp on the side
	V1-G-2M-PUR	Female cordset single-ended M12 straight A-coded, 4-pin, PUR cable grey
	V1-W-2M-PUR	Female cordset single-ended M12 angled A-coded, 4-pin, PUR cable grey

Release date: 2023-10-13 Date of issue: 2023-10-13 Filename: 183810_eng.pdf