

Optical data coupler LS610-DA-P/F1/146

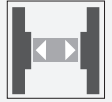

- Devices for PROFIBUS
- Version for low temperature applications
- Problem-free light beam interruption due to TVT (Telegram Verification Technology)
- Plug connection for fast mounting
- Simple programming without opening the device
- Usable up to detection range 0
- Line indicator for signal strength

Optical data coupler for PROFIBUS, 120 m detection range, infrared light, M12 plug, low temperature version



Dimensions

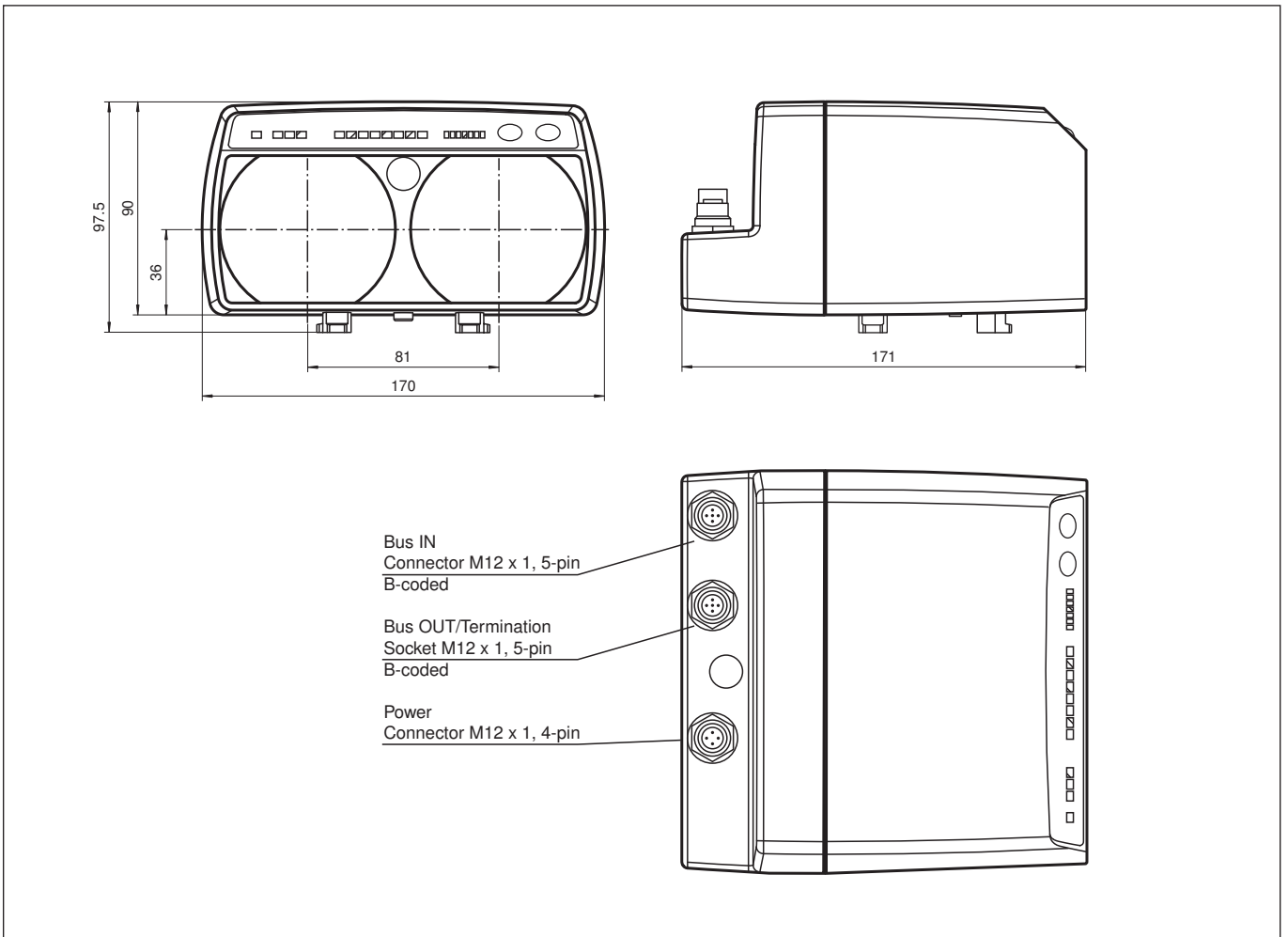

Release date: 2021-11-11 Date of issue: 2021-11-11 Filename: 185149_eng.pdf

Technical Data

General specifications		
Effective detection range		0 ... 120 m
Threshold detection range		140 m
Light type		modulated infrared light
Diameter of the light spot		2 m at a distance of 100 m
Angle of divergence		1.1 °
Ambient light limit		> 10000 Lux
Functional safety related parameters		
MTTF _d		250 a
Mission Time (T _M)		20 a
Diagnostic Coverage (DC)		0 %
Indicators/operating means		
Data flow indicator		LED green: emitter LED yellow: receiver LED red: faulty telegram
Function indicator		alignment aid: flashing front red LED Signal strength (8 LED: Red, yellow, green) Baudrate, operating mode
Control elements		membrane keys, 2 keys, can be electrically locked
Electrical specifications		
Operating voltage	U _B	18 ... 30 V DC
No-load supply current	I ₀	200 mA
Data rate		93.75; 187.5;(350); 500;1500 kBit/s , adjustable
Operation frequency		F1 = 8.25 MHz
Interface		
Interface type		PROFIBUS, galvanically isolated
Input		
Function input		Keylock, internal Pull-up resistor keypad locked with 0 V
Output		
Pre-fault indication output		1 PNP (switches if there is sufficient stability control) short-circuit protected, max. 200 mA
Conformity		
Product standard		EN 60947-5-2
Approvals and certificates		
EAC conformity		TR CU 020/2011
Approvals		CE, cULus
Ambient conditions		
Ambient temperature		-30 ... 50 °C (-22 ... 122 °F) , For use in dry cold
Storage temperature		-30 ... 70 °C (-22 ... 158 °F)
Mechanical specifications		
Degree of protection		IP65
Connection		4-pin, M12x1 connector, standard (supply) , 5-pin, M12x1 connector, B-coded (Bus In) , 5-pin, M12x1 socket, B-coded (Bus Out/Termination)
Material		
Housing		ABS / PC
Optical face		plastic
Mass		700 g

Connection Assignment

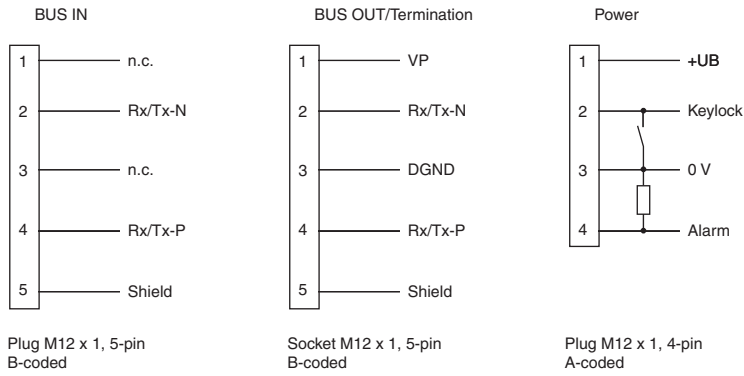

Characteristic Curve

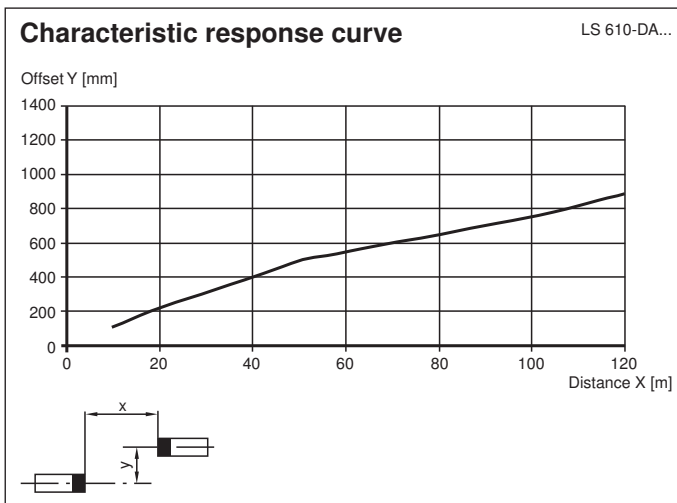





Release date: 2021-11-11 Date of issue: 2021-11-11 Filename: 185149_eng.pdf

Accessories

	ICZ-TR-V15B	Terminal resistor for PROFIBUS
	V15-G-PG9	Female connector, M12, 5-pin, field attachable
	Funktionserdung LS610/VDM100 Zubehoer	Function grounding for LS610 / LS611 / VDM100 series
	Schutzkappe LS610 Zubehoer	M12 protective cap set (connector + socket) for series LS610 / LS611

Accessories

	OMH-LS610-01	Mounting bracket for optical data coupler
	OMH-LS610-01	Mounting bracket for optical data coupler
	OMH-LS610-02	Direct mounting set consisting of 4 x M4 threaded inserts
	OMH-LS610-03	Mounting bracket with deviation mirror for optical data coupler
	OMH-LS610-32	Mounting bracket for optical data coupler and distance measurement devices

Additional Information

Function

The LS610-DA-P is a device for serial data transmission in PROFIBUS-Systems at transmission rates up to 1500 kbit/s and a distance range covering up to 240 m. Of course the device can be employed at transmission rates and distance below these values without any problems. A data transmission path consists of two devices LS 610-DA-P, one working at centre frequency F1 and one working at centre frequency F2.

Data transmission

The data transmission is carried out by means of modulated infrared light in both directions. In the Emitter, the input interface information is modulated onto the carrier signal by frequency shift keying (FSK) in real time. In the receiver the incoming optical signal is de-modulated and made available at the output interface.

Function indicators/Function reserve

As adjustment aid, the device is equipped with a alignment LED, which can be observed over a long distance. As soon as a receiver detects an incoming optical signal from the opposite device, the alignment LED's flashing frequency slows down. Going out indicates a good alignment and sufficient function reserve. For fine adjustment the device is equipped additional with a bar graph-Indicator (signal-indicator), which makes an optimal alignment possible.

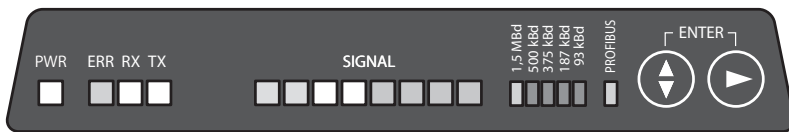

State	weak signal	sufficient signal strength	signal with function reserve
Transmission	blocked	released	transmission with function reserve
Alignment-LED	fast flashing	slow flashing	off
Signal-indicator	red area	yellow area (at least one LED)	green area

Connection between indicator and device status

If the bus is active, a yellow LED „RX“ (receive data) and a green LED „TX“ (transmit data) light up.

Operating

Due to two membrane keys, parameters like transfer rate and telegram verification can be selected and modified. The visualization of ready status, data transfer and error message is carried out via LEDs. to avoid manipulation or inadvertently parameter change the keys can be electrically locked.

Telegram processing

To avoid bus error, caused by light beam interruption, Telegram Verification Technology (TVT) is implemented in this device. The TVT prevents from transfers of invalid telegrams. The data get recovered bit by bit and word-fairly and are applied to the bus quartz-stabilized. Thus an optimal signal conditioning is performed. The signals are electrically identical and simultaneous to the original PROFIBUS clients signals.

The TVT can be de-activated. Due to this, the data transfer is mostly protocol free and the device is suitable for transferring RS485 protocols, which have different timing conditions to the PROFIBUS.

Bus termination

If the data coupler is located at the end of a bus topology, a bus termination is required. An external standard termination resistor (refer accessories) has to be connected to the M12 connector „Bus OUT/Termination“.

Installation

The mounting is carried out by using the suitable mounting accessory e. g. OMH-LS610-01 for wall mounting.

The x-y-adjustable carrier is delivered pre-assembled. It can be mounted in the desired direction (±90° rotation is possible) It may be tightened not before mounting onto the mounting bracket by means of 2 M4-screws and the central M6-screw. The final fixation after alignment is carried out by means of the central screw.

The data coupler can be snapped onto the alignment fixture, when the both spring forced handles at the front end of the fixture are pressed together. After snap in, the handles must be released for a reliable fixation of the device.

By means of the two adjustment screws (female hexagon 5 mm) the beam axis can be aligned in X- and Y-direction. Finally the alignment gets fixed by tightening the central screw.

Release date: 2021-11-11 Date of issue: 2021-11-11 Filename: 185149_eng.pdf