



Diffuse mode sensor

RL31-8-1200-RT/59/73c/136



- Highly visible LED
- Powerful push-pull output
- Red transmission light
- Compact and stable housing
- Protection class II

Diffuse mode sensor, plastic housing, 1200 mm adjustable detection range, red light, dark on, push-pull output, M12 plug

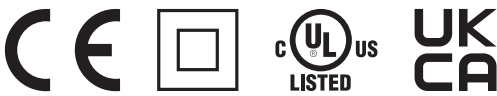

Dimensions

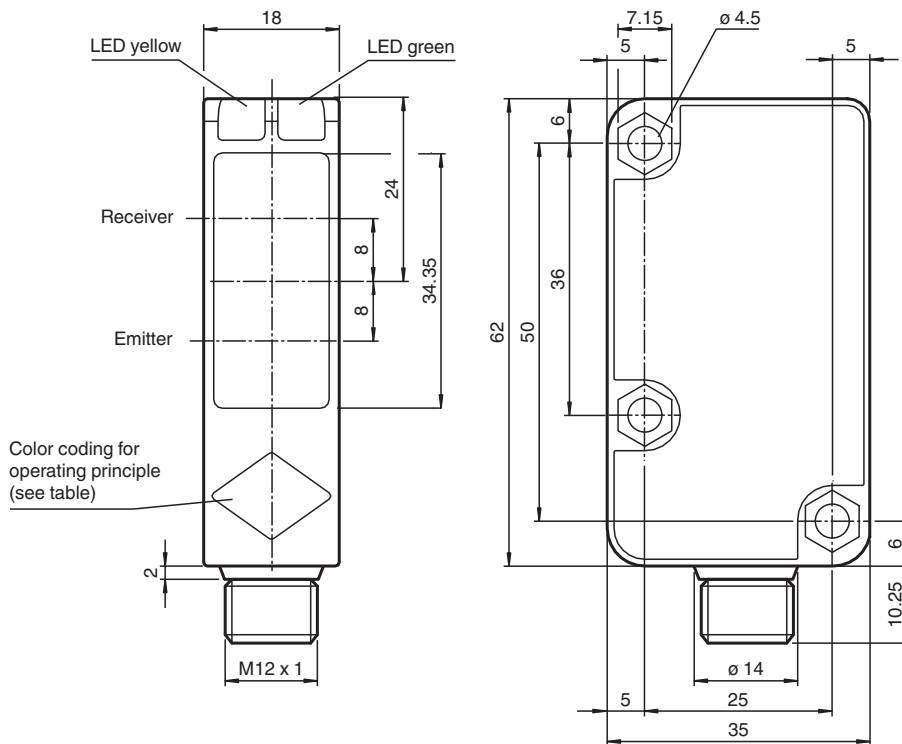

| Operating principle | color |
|---|-------|
| Retroreflective sensor with polarisation filter | green |
| Retroreflective sensor | blue |
| Diffusive mode sensor | white |
| Thru-beam sensor | grey |
| Diffusive mode sensor with background suppression | red |

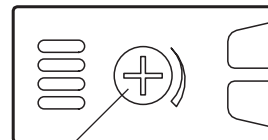

Sensing range adjuster

Technical Data

General specifications

Detection range 0 ... 1200 mm adjustable

Release date: 2023-10-13 Date of issue: 2023-10-13 Filename: 186474_eng.pdf

Technical Data

| | | |
|---|----------------|---|
| Detection range max. | | 0 ... 1200 mm |
| Reference target | | standard white, 100 mm x 100 mm |
| Light source | | LED |
| Light type | | modulated visible red light , 630 nm |
| Diameter of the light spot | | approx. 25 mm at a distance of 1.2 m |
| Opening angle | | 2 ° |
| Ambient light limit | | 50000 Lux ; according to EN 60947-5-2 |
| Functional safety related parameters | | |
| MTTF _d | | 920 a |
| Mission Time (T _M) | | 20 a |
| Diagnostic Coverage (DC) | | 0 % |
| Indicators/operating means | | |
| Operation indicator | | LED green: power on |
| Function indicator | | LED yellow, lights up with receiver lit |
| Control elements | | Sensing range adjuster |
| Electrical specifications | | |
| Operating voltage | U _B | 10 ... 30 V DC |
| Ripple | | 10 % |
| No-load supply current | I ₀ | ≤ 20 mA |
| Output | | |
| Switching type | | dark-on |
| Signal output | | 2 push-pull (4 in 1) outputs, short-circuit protected, reverse polarity protected |
| Switching voltage | | max. 30 V DC |
| Switching current | | max. 100 mA |
| Voltage drop | U _d | ≤ 1.5 V |
| Switching frequency | f | ≤ 500 Hz |
| Response time | | ≤ 1 ms |
| Conformity | | |
| Product standard | | EN 60947-5-2 |
| Approvals and certificates | | |
| Protection class | | II , rated insulation voltage ≤ 250 V AC with pollution degree 1-2 according to IEC 60664-1 Output circuit basis insulation of input circuit according to EN 50178, rated insulation voltage 240 V AC |
| UL approval | | cULus Listed, Class 2 Power Source, Type 1 enclosure |
| CCC approval | | CCC approval / marking not required for products rated ≤36 V |
| Ambient conditions | | |
| Ambient temperature | | -30 ... 55 °C (-22 ... 131 °F) |
| Storage temperature | | -40 ... 70 °C (-40 ... 158 °F) |
| Mechanical specifications | | |
| Housing width | | 18 mm |
| Housing height | | 62 mm |
| Housing depth | | 35 mm |
| Degree of protection | | IP67 |
| Connection | | 4-pin, M12 x 1 connector |
| Material | | |
| Housing | | Polycarbonate |
| Optical face | | PMMA |
| Mass | | 25 g |

Connection Assignment

Option:

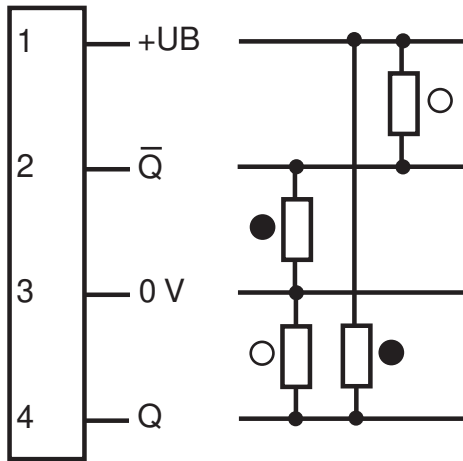

Connection Assignment

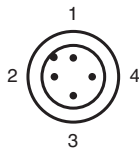

Wire colors in accordance with EN 60947-5-2

| | | |
|---|----|---------|
| 1 | BN | (brown) |
| 2 | WH | (white) |
| 3 | BU | (blue) |
| 4 | BK | (black) |

Assembly

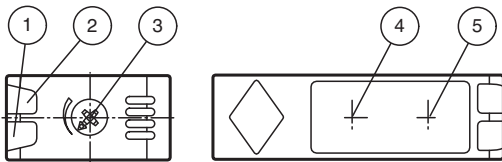



| | | |
|---|------------------------|--------|
| 1 | Operating display | green |
| 2 | Signal display | yellow |
| 3 | Sensing range adjuster | |
| 4 | Emitter | |
| 5 | Receiver | |

Release date: 2023-10-13 Date of issue: 2023-10-13 Filename: 186474_eng.pdf

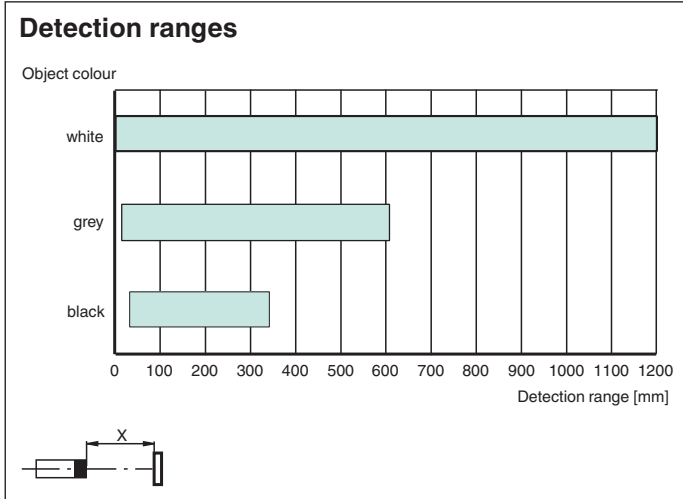
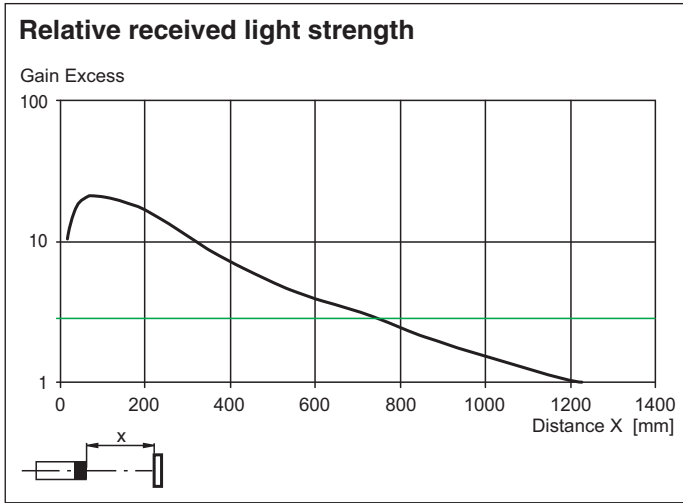
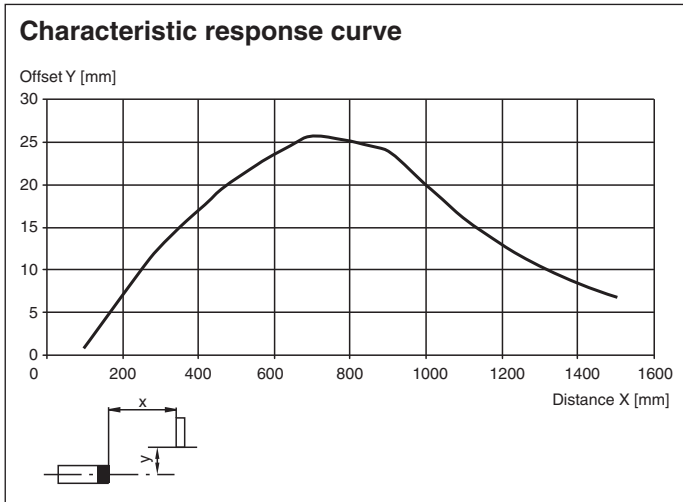
Characteristic Curve







Accessories

| | | |
|---|--------------------|-------------------------|
|  | OMH-RL31-01 | Mounting bracket |
|  | OMH-RL31-02 | Mounting bracket narrow |
|  | OMH-RL31-03 | Mounting bracket narrow |

Release date: 2023-10-13 Date of issue: 2023-10-13 Filename: 186474_eng.pdf

Accessories

| | | |
|---|--------------------|---|
|  | OMH-RL31-04 | Mounting aid for round steel \varnothing 12 mm or sheet 1.5 mm ... 3 mm |
|  | OMH-RL31-05 | Mounting bracket for mounting on flat surfaces with 2 M4 screws |
|  | OMH-RL31-06 | Stainless steel mounting bracket with adjustable half clamp on the side |
|  | V1-G-2M-PUR | Female cordset single-ended M12 straight A-coded, 4-pin, PUR cable grey |
|  | V1-W-2M-PUR | Female cordset single-ended M12 angled A-coded, 4-pin, PUR cable grey |