

# Inductive ring sensor RC15-14-N3-Y187458

■ 15 mm inside diameter

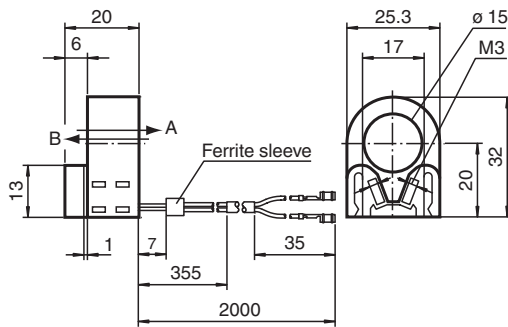

## Dimensions



## Technical Data

### General specifications

Switching function	Normally closed (NC)
Output type	NAMUR, bistable
Inside diameter	15 mm
Measuring cone	6 mm, 1.4401
Passage speed	v ≤ 10 m/s
Output type	2-wire

### Nominal ratings

Nominal voltage	$U_o$	8.2 V ( $R_i$ approx. 1 k $\Omega$ )
Operating voltage	$U_B$	5 ... 25 V
Hysteresis	H	typ. 1 %
Reverse polarity protection		reverse polarity protected
Current consumption		
Passage B $U_B=8V$		≥ 3 mA
Passage B $U_B=10V$		≥ 4.2 mA
Passage A $U_B=10V$		0.5 ... 1 mA typ. 0.9 mA
Passage A $U_B=8V$		0.5 ... 0.95 mA typ. 0.8 mA
Power ON		≥ 3 mA with $U_B = 8 V$ ≥ 4.2 mA at $U_B = 10$
Time delay before availability	$t_v$	≤ 5 ms

### Functional safety related parameters

MTTF <sub>d</sub>	2130 a
Mission Time ( $T_M$ )	20 a
Diagnostic Coverage (DC)	0 %

### Compliance with standards and directives

Standard conformity	
NAMUR	EN 60947-5-6:2000 IEC 60947-5-6:1999
Standards	EN IEC 60947-5-2

Release date: 2025-05-13 Date of issue: 2025-05-13 Filename: 187458\_eng.pdf

## Technical Data

### Approvals and certificates

ATEX approval	
Equipment protection level Gb	PTB 99 ATEX 2128 X
UL approval	cULus Listed, General Purpose

### Ambient conditions

Ambient temperature	-25 ... 75 °C (-13 ... 167 °F)
Storage temperature	-40 ... 100 °C (-40 ... 212 °F)

### Mechanical specifications

Connection type	cable PVC , 2 m Crimp terminal sockets 60888-3, AMP
Core cross section	0.14 mm <sup>2</sup>
Housing material	PBT
Degree of protection	IP67
Cable	
Bending radius	> 10 x cable diameter
Mass	36 g
Dimensions	
Height	32.5 mm
Width	25 mm
Length	20 mm

### General information

Use in the hazardous area	see instruction manuals
---------------------------	-------------------------

## Connection

