



AS-Interface sensor module

VAA-4E-G4-ZE

- Degree of protection IP67
- Flat or round cable connection (via standardized EMS base, not included with delivery)
- Cable piercing method for flat cable
- Inputs for 2- and 3-wire sensors
- Power supply of inputs from the module
- Function display for bus and inputs
- LED indicator for overload on sensor supply

G4 module IP67/4 inputs (PNP)



Function

The VAA-4E-G4-ZE AS-Interface coupling module is a G4 module with 4 inputs. Mechanical contacts and 2- and 3-wire sensors can be connected to the inputs. The sensors are supplied via the module. The IP67 rated G4 module is especially suitable for rough conditions. Sensors attach to cable glands and cage tension spring terminals thus making the installation especially user-friendly. For pre-addressing the module it can be plugged directly onto the adapter of the hand-held programming device VBP-HH1.

The current switching state of each channel is indicated by an LED, located on the module's top side.

Both flat and round cables can be used for the connection of the AS-Interface transmission line. Use the U-G1F base or the U-G1FF base for the AS-Interface flat cable. The AS-Interface cable is connected using the cable piercing method. The U-G1F base can also be used as IP67 AS-Interface distribution box. The U-G1FF base should be used, when modules with outputs are mounted in series with the module. The flat cable for external power supply can be placed in this base. The module does not access the supply line.

Use the U-G1P or the U-G1PP base for a round cable. These bases have the same functionality as the U-G1F or the U-G1FF bases.

Note:

An overloading of the sensor supply, e. g. short-circuit is signalled by a red/green flashing LED "PWR/FAULT" and reported to the AS-Interface master via the "Peripheral fault" function. Communication via the AS-Interface remains intact.

Dimensions

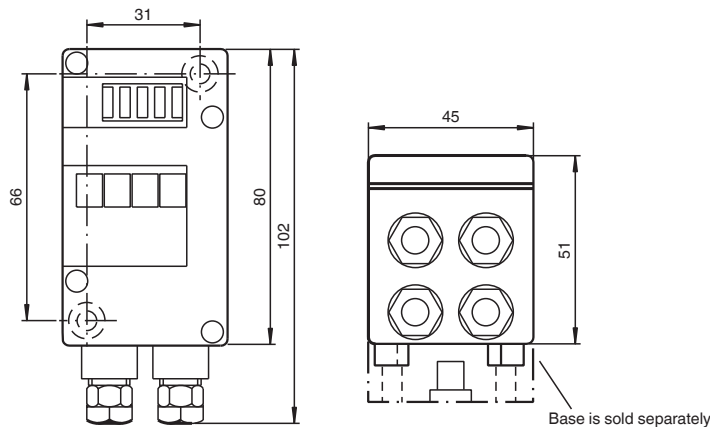

Technical Data

General specifications

Node type	Standard node
AS-Interface specification	V3.0
Required gateway specification	≥ V2.0
UL File Number	E223772

Indicators/operating means

Release date: 2023-05-09 Date of issue: 2023-05-09 Filename: 187946_eng.pdf

Technical Data

LED PWR/FAULT		dual LED green/red green: AS-Interface voltage red: communication error or address 0 green/red flashing: overload sensor supply
LED IN		switching state (input); 4 LED yellow
Electrical specifications		
Rated operating voltage	U_e	26.5 ... 31.6 V from AS-Interface
Rated operating current	I_e	≤ 40 mA (without sensors) / max. 190 mA
Protection class		III
Surge protection		U_e : Over voltage category III, safe isolated power supplies (PELV)
Input		
Number/Type		4 inputs for 2- or 3-wire sensors (PNP), DC
Supply		from AS-Interface
Voltage		21 ... 31 V
Current loading capacity		≤ 150 mA ($T_B \leq 40 \text{ °C}$), ≤ 120 mA ($T_B \leq 60 \text{ °C}$), short-circuit protected
Input current		≤ 8 mA (limited internally)
Switching point		according to DIN EN 61131-2 (Type 2)
0 (unattenuated)		≤ 2 mA
1 (attenuated)		≥ 4 mA
Directive conformity		
Electromagnetic compatibility		
Directive 2014/30/EU		EN 62026-2:2013 EN 61000-6-2:2005 EN 61000-6-4:2007
Standard conformity		
Degree of protection		EN 60529:2000
Fieldbus standard		EN 62026-2:2013
Input		EN 61131-2:2007
Emitted interference		EN 61000-6-4:2007
AS-Interface		EN 62026-2:2013
Noise immunity		EN 61000-6-2:2005
Programming instructions		
Profile		S-0.0
IO code		0
ID code		0
ID1 code		F
ID2 code		E
Data bits (function via AS-Interface)		Input Output
D0		IN1 -
D1		IN2 -
D2		IN3 -
D3		IN4 -
Parameter bits (programmable via AS-i)		function
P0		not used
P1		not used
P2		not used
P3		not used
Ambient conditions		
Ambient temperature		-25 ... 60 °C (-13 ... 140 °F)
Storage temperature		-25 ... 85 °C (-13 ... 185 °F)
Relative humidity		85 % , noncondensing
Climatic conditions		For indoor use only
Altitude		≤ 2000 m above MSL
Pollution degree		3
Mechanical specifications		

Technical Data

Degree of protection	IP67
Connection	cable piercing method or terminal compartment yellow flat cable or standard round cable inputs: M12 x 1.5 cable gland and cage tension spring terminals
Material	
Housing	PA 6 GF30
Mass	180 g
Tightening torque, housing screws	0.8 Nm
Mounting	DIN rail or screw mounting

Connection

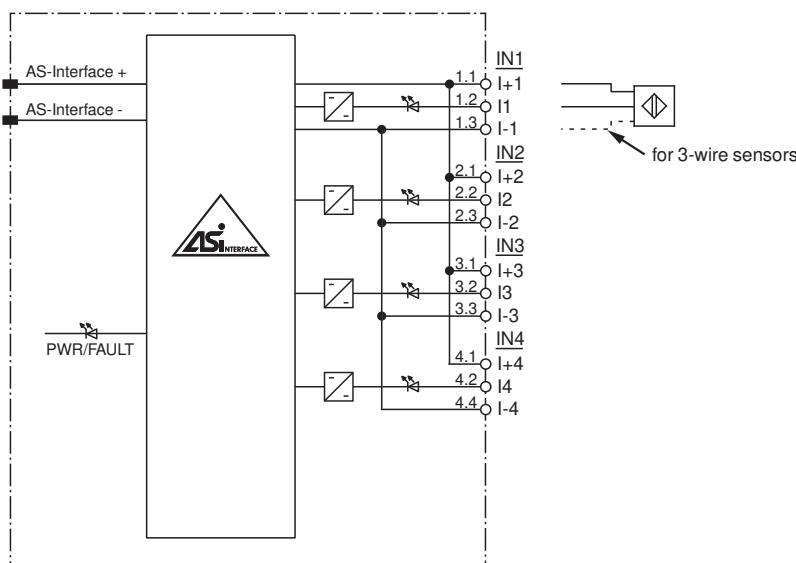

Connection

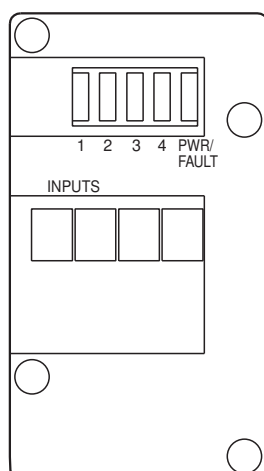

Do not connect inputs and outputs, which are supplied via the module from AS-interface or via auxiliary power, with power supply and signal circuits with external potentials.

Assembly





Release date: 2023-05-09 Date of issue: 2023-05-09 Filename: 187946_eng.pdf

Matching System Components

	U-G1F	AS-Interface module mounting base for connection to flat cable (AS-Interface)
	U-G1P	AS-Interface module mounting base for connection to round cable (AS-Interface)

Accessories

	VBP-HH1-V3.0-KIT	AS-Interface Handheld with accessory
	VAZ-G4-B1	Blind plug M12