

Inductive positioning system

PMI104-F90-IU-V1



- Analog output 0 V ... 10 V/4 mA ... 20 mA
- Measuring range 0 ... 104 mm



Dimensions

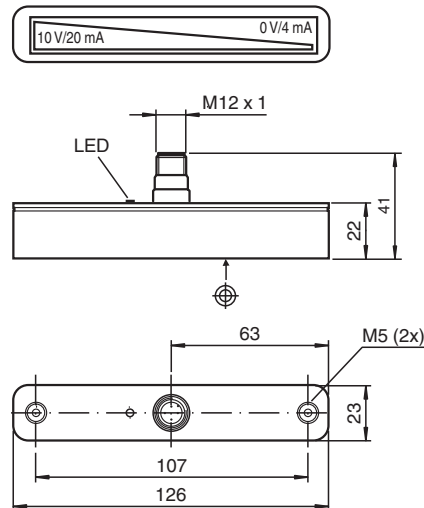

Technical Data

| General specifications | | |
|--------------------------------------|-------|------------------------------------------------------------------------------|
| Switching element function | | analog, current or voltage output |
| Object distance | | 0.5 ... 3 mm , recommended: 2 mm |
| Measurement range | | 0 ... 104 mm |
| Linearity range | | 1 ... 103 mm |
| Nominal ratings | | |
| Operating voltage | U_B | 18 ... 30 V DC |
| Reverse polarity protection | | reverse polarity protected |
| Linearity error | | within measuring range: ± 0.8 mm within linearity range: ± 0.4 mm |
| Repeat accuracy | R | ± 0.1 mm |
| Resolution | | 125 μ m |
| Temperature drift | | ± 0.5 mm (-25 °C ... 70 °C) |
| No-load supply current | I_0 | ≤ 40 mA |
| Operating voltage indicator | | LED green |
| Functional safety related parameters | | |
| MTTF _d | | 320 a |

Release date: 2024-06-24 Date of issue: 2024-06-24 Filename: 191135_eng.pdf

Technical Data

| | |
|-------------------------------------------------|------------------------------------------------------------------------------------|
| Mission Time (T _M) | 20 a |
| Diagnostic Coverage (DC) | 0 % |
| Analog output | |
| Output type | 1 current output: 4 ... 20 mA 1 voltage output: 0 ... 10 V |
| Load resistor | current output: ≤ 400 Ω voltage output: ≥ 1000 Ω |
| Short-circuit protection | voltage output: pulsing |
| Compliance with standards and directives | |
| Standard conformity | |
| Standards | EN 60947-5-2:2007 IEC 60947-5-2:2007 EN 60947-5-7:2003 IEC 60947-5-7:2003 |
| Approvals and certificates | |
| UL approval | cULus Listed, General Purpose, Class 2 Power Source |
| CCC approval | CCC approval / marking not required for products rated ≤36 V |
| Ambient conditions | |
| Ambient temperature | -25 ... 70 °C (-13 ... 158 °F) |
| Mechanical specifications | |
| Connection type | 4-pin, M12 x 1 connector |
| Degree of protection | IP67 |
| Material | |
| Housing | ABS |
| Target | mild steel, e. g. 1.0037, SR235JR (formerly St37-2) |
| Dimensions | |
| Height | 41 mm |
| Width | 23 mm |
| Length | 126 mm |

Connection

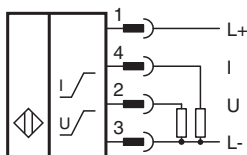

Connection Assignment

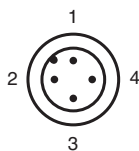

Connection Assignment

Wire colors in accordance with EN 60947-5-2

| | | |
|---|----|---------|
| 1 | BN | (brown) |
| 2 | WH | (white) |
| 3 | BU | (blue) |
| 4 | BK | (black) |

dimensions for the target object:

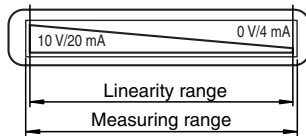
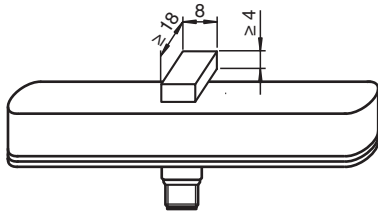

Operation

Operating instructions

- Safety information
 -  This product may not be used in applications where personal safety depends on the function of the device.
This product is not a safety component as described in EU Machinery Directive.

- Sensor versions
 - The F90 linear position measurement system is available in 2 versions.
In the PMI...-F90-IU-V1 version, the position measuring system transmits current and voltage signals proportional to the position of the damping element at the outputs.
The PMI...-F90-IE8-V15 version offers a current signal as well as the option of teaching in two switching points directly at the sensor independently of one another at the press of a button, which is then indicated on two switching outputs. Two additional LEDs indicate the output states of the two switching outputs.

Version PMI...-F90-IU-V1

Output signals: 4 mA ... 20 mA and 0 V ... 10 V



Only the current output or the voltage output may be used. The unused output must remain load free.

Version PMI...-F90-IE8-V15

Output signals: 4 mA ... 20 mA and 2 programmable switching amplifiers

- Programming the PMI...-F90-IE8-V15
 - The rear of the PMI...-F90-IE8-V15 sensor has two small, slightly recessed push buttons for programming the switching points. The buttons are marked "teach in" and S1 for switching point S1 and S2 for switching point S2.

To teach in a switching point, proceed as follows:

- The position detection damping element must be placed at the relevant position, i.e. the switching point that you wish to teach in.
- Press the corresponding push button for at least two seconds.
The associated switching state LED starts flashing to indicate that the sensor is now in "teach mode".
- Press the button again to confirm the relevant switching point.

The switching state LED then lights up constantly as long as the damping element is not moved.

The switching point is now taught in and the associated switching point changes to an active state within an actuator adjustment range of ± 1 mm around the taught switching point.



If the switching point is not confirmed within 80 seconds, the sensor exits "teach mode" and continues operation with the previous values.

- Damping element
 - The linear position measurement system is adapted perfectly to the geometry of the damping elements offered in our product range.



When using other damping elements, always make sure that the active surface of the damping element has a width of exactly 8 mm and covers the entire width of the sensor.

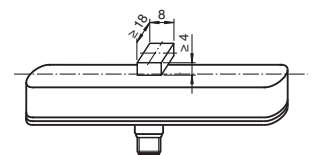

- Installation and operation

Instructions on installation

- Flush installation is possible
- to extend the measuring range, units from the -F90 linear position measurement system can be connected in series (both behind and adjacent to one another) without a minimum distance.
- The minimum distance between the measuring field (framed area on the sensor front) and mounting base or mounting elements on the damping element must be 3 mm.

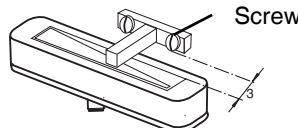
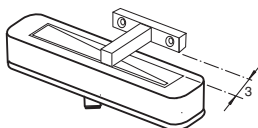
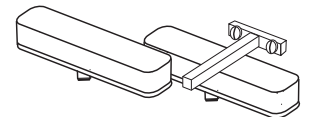

- Operating information

The specified measurement accuracy is achieved with an actuator distance of 1 to 3 mm.

If the damping element leaves the measuring area (illustration below):

- the last valid value is retained at the voltage output (PMI...-F90-IU-V1 only) until the damping element enters the valid area again.
- the last valid value is retained for 0.5 seconds at the current output (all types). The output then switches to a fault current of 3.6 mA until the damping element enters the valid area again.

Release date: 2024-06-24 Date of issue: 2024-06-24 Filename: 191135_eng.pdf

- the switching amplifiers set to basic state after 0.5 seconds ("normally open").

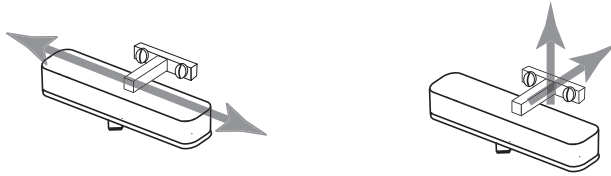

- Defining the measuring range / measured position
The measured position of the damping element (actuator) is based on half of the width (center of the actuator). The measuring range starts and finishes when half the width of the actuator covers the measurement field marked on the sensor when the actuator makes a longitudinal movement (see left illustration above).

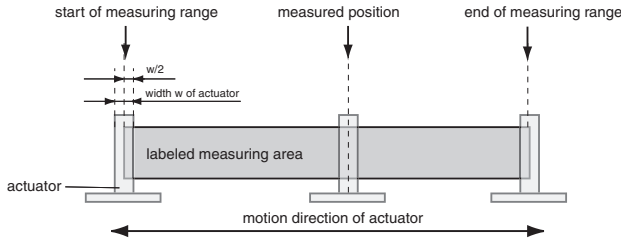

- Accessories

Damping elements
BT-F90-W



Mounting bracket
MH-F90



- Straight cable:**V1-G-2M-PVC (4-wire)
V15-G-2M-PVC (5-wire)
- Angled cable:**V1-W-2M-PVC (4-wire)
V15-W-2M-PVC (5-wire)