



Ultrasonic sensor

UC500-30GM-IUEP-IO-V15

- IO-Link interface for service and process data
- Programmable via DTM with PACTWARE
- Switch output and analog output
- Selectable sound lobe width
- Synchronization options
- Temperature compensation

Single head system



Dimensions

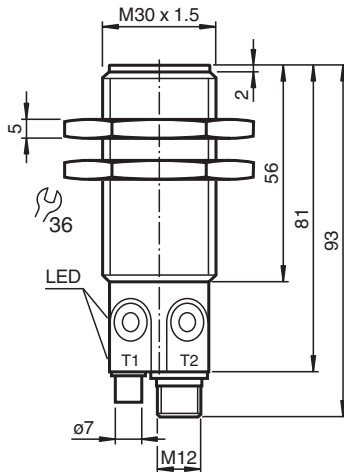

Technical Data

General specifications	
Sensing range	30 ... 500 mm
Adjustment range	50 ... 500 mm
Dead band	0 ... 30 mm
Standard target plate	100 mm x 100 mm
Transducer frequency	approx. 380 kHz
Response delay	minimum : 25 ms factory setting: 45 ms
Memory	
Non-volatile memory	EEPROM
Write cycles	100000
Indicators/operating means	
LED green	solid: Power on flashing: Standby mode or IO link communication
LED yellow 1	solid: Object in evaluation range flashing: Learning function, object detected
LED yellow 2	solid: Object in evaluation range flashing: Learning function, object detected

Release date: 2025-06-12 Date of issue: 2025-06-15 Filename: 191238_eng.pdf

Technical Data

LED red		solid red: Error red, flashing: program function, object not detected
Electrical specifications		
Operating voltage	U_B	10 ... 30 V DC , ripple 10 % _{SS} 15 ... 30 V voltage output
No-load supply current	I_0	≤ 60 mA
Power consumption	P_0	≤ 1 W
Time delay before availability	t_v	≤ 100 ms
Interface		
Interface type		IO-Link
Protocol		IO-Link V1.0
Transfer rate		Acyclical: typical 240 Bit/s
Cycle time		min. 13.2 ms
Mode		COM2 (38.4 kBit/s)
Process data width		16 bit
SIO mode support		yes
Input/Output		
Input/output type		1 synchronization connection, bidirectional
0 Level		0 ... 1 V
1 Level		4 V ... U_B
Input impedance		> 12 k Ω
Output current		< 12 mA
Pulse length		0.5 ... 300 ms (level 1)
Pulse interval		≥ 14 ms (level 0)
Synchronization frequency		
Common mode operation		≤ 70 Hz
Multiplex operation		≤ 90 Hz / n , n = number of sensors , n ≤ 10 (factory setting: n = 5)
Output		
Output type		1 push-pull (4 in 1) output, short-circuit protected, reverse polarity protected Current output 4 mA ... 20 mA or voltage output 0 V ... 10 V configurable
Rated operating current	I_e	200 mA , short-circuit/overload protected
Voltage drop	U_d	≤ 2.5 V
Resolution		current output: evaluation range [mm]/3200 but ≥0.05 mm voltage output: evaluation range [mm]/4000 but ≥0.05 mm
Deviation of the characteristic curve		≤ 0.2 % of full-scale value
Repeat accuracy		≤ 0.1 % of full-scale value
Switching frequency	f	≤ 11 Hz
Range hysteresis	H	1 % of the adjusted operating range (default settings), programmable
Load impedance		current output: ≤ 300 Ohm voltage output: ≥ 1000 Ohm
Temperature influence		≤ 1.5 % from full-scale value (with temperature compensation) ≤ 0.2 %/K (without temperature compensation)
Compliance with standards and directives		
Standard conformity		
Standards		EN IEC 60947-5-2:2020 IEC 60947-5-2:2019 EN 60947-5-7:2003 IEC 60947-5-7:2003
Approvals and certificates		
UL approval		cULus Listed, Class 2 Power Source
CCC approval		CCC approval / marking not required for products rated ≤36 V
Ambient conditions		
Ambient temperature		-25 ... 70 °C (-13 ... 158 °F)
Storage temperature		-40 ... 85 °C (-40 ... 185 °F)
Mechanical specifications		

Technical Data

Connection type	Connector plug M12 x 1 , 5-pin
Degree of protection	IP67
Material	
Housing	Stainless steel 1.4305 / AISI 303 TPU Polyamides
Transducer	epoxy resin/hollow glass sphere mixture; polyurethane foam
Mass	66 g
Dimensions	
Length	93 mm
Diameter	30 mm
Factory settings	
Output 1	near switch point: 50 mm far switch point: 500 mm Output mode: Window mode output behavior: NO contact
Output 2	near limit: 100 mm far limit: 250 mm Output mode: rising ramp output behavior: Current output 4 mA ... 20 mA
Beam width	wide

Connection Assignment

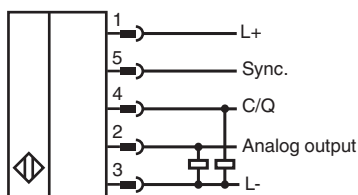

Connection Assignment

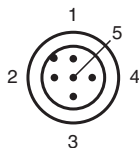

Wire colors in accordance with EN 60947-5-2

1	BN	(brown)
2	WH	(white)
3	BU	(blue)
4	BK	(black)
5	GY	(gray)

Release date: 2025-06-12 Date of issue: 2025-06-15 Filename: 191238_eng.pdf

Characteristic Curve

Characteristic response curve

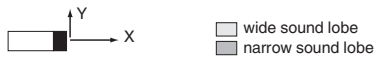
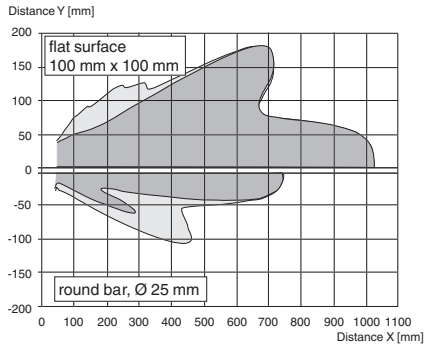

Switching output operating modes

1. Switching point mode

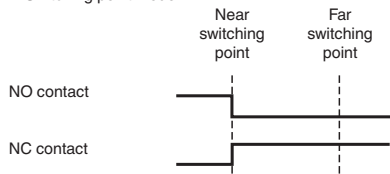

2. Window mode

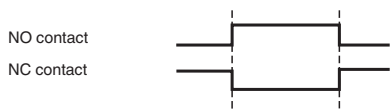

3. Hysteresis mode

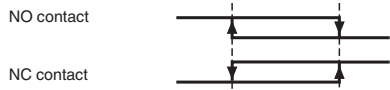

4. Retroreflective sensor mode

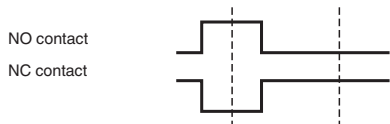

Analog output operating modes

Analog functions

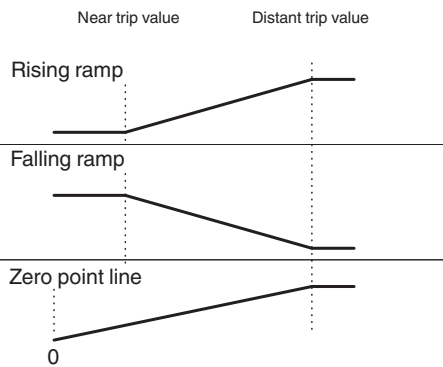

Release date: 2025-06-12 Date of issue: 2025-06-15 Filename: 191238_eng.pdf

Programming

Programming

The sensor is equipped with two outputs. Two switching points or trip values as well as the output mode, can be programmed for each output. The shape of the sensor sound cone can also be programmed. These parameters can be configured using two different methods:

- Using the sensor push buttons
- Using the IO-link interface of the sensor. This method requires an IO-link master (e.g. IO-link master01 USB) and the associated software. The download link is available on the product page for the sensor with the IO link at www.pepperl-fuchs.de

Configuration using the push buttons is described below. To configure the parameters using the sensor IO-link interface, please read the software description. The processes for configuring the switching points and the sensor operating modes run completely independently and do not influence one another.

Note:

- The sensor can only be programmed during the first 5 minutes after switching on. This time is extended during the actual programming process. The option of programming the sensor is revoked if no programming activities take place for 5 minutes. After this, programming is no longer possible until the sensor is switched off and on again.
- The programming activities can be canceled at any time without changing the sensor settings. To do so, press and hold the push button for 10 seconds.

Programming the switching point/trip value of the analog characteristic

Note:

Each push button is assigned to a physical output. The switching output (C/Q) is programmed via push button T1. The analog output is programmed via push button T2.

A flashing red LED during the programming process indicates unreliable object detection. Should this occur, correct the alignment of the object until the yellow LED L1 or L2 flashes. Only then will the settings be transferred to the sensor memory.

Programming the switching points/trip values using the push button

Programming the near switching point/trip value of the analog characteristic

1. Position the object at the site of the required near switching point or trip value.
2. Press and hold the push button for 2 seconds (yellow LED flashes)
3. Briefly press the push button (green LED flashes 3 times as confirmation). The sensor returns to normal mode.

Programming the far switching point/trip value of the analog characteristic

1. Position the object at the site of the required far switching point or trip value.
2. Press and hold the push button for 2 seconds (yellow LED flashes)
3. Press and hold the push button for 2 seconds (green LED flashes 3 times as confirmation). The sensor returns to normal mode.

Programming the operating modes

The sensor features a 3-stage process for programming the sensor operating modes. You can program the following with this process:

1. Output mode
2. Output behavior of the switching output/analog output
3. The shape of the sound cone

These two stages of the process are programmed in succession. To switch from one programming function to the next, press and hold the push button for 2 seconds.

Accessing the programming routine

The operating mode can be programmed separately for each of the two switching outputs. The operating mode of the switching output (C/Q) is programmed via push button T1. The operating mode of the analog output is programmed via push button T2.

To access the programming routine for the sensor operating mode, press the push button for 5 seconds.

Programming the output mode

The green LED is now flashing. The number of flashes indicates the output function currently programmed:

Switching output	Analog output
1x: Switching point mode	1x: rising slope
2x: Window mode	2x: falling slope
3x: Hysteresis mode	3x: zero point line
4x: Retroreflective sensor mode	

1. Briefly press the push button to navigate through the output configurations in succession. Use this method to choose the required output mode.
2. Press and hold the push button for 2 seconds to save the selection and switch to the programming routine for the output behavior.

Programming the output behavior

The yellow LED is now flashing. The number of flashes indicates the output behavior currently programmed:

Switching output	Analog output
1x: NO contact	1x: Current output (4–20 mA)
2x: NC contact	2x: Voltage output (0–10 V)
	3x: Deactivated: high impedance

1. Briefly press the push button to navigate through the output behaviors in succession. Use this method to choose the required output function.
2. Press and hold the push button for 2 seconds to save the selection and switch to the programming routine for the sound cone.

Programming the shape of the sound cone

The red LED is now flashing. The number of flashes indicates the sound cone shape currently programmed:

- 1x: narrow
- 2x: medium
- 3x: wide

1. Briefly press the push button to navigate through the different sound cone shapes in succession. Use this method to choose the required sound cone shape.
2. Press and hold the push button for 2 seconds to return to normal mode.

Note

The last sound cone shape programmed applies for both outputs in equal measure.

Factory Setting

Resetting the sensor to the factory settings

The sensor can be reset to the original factory settings.

1. Disconnect the sensor from the power supply
2. Press and hold one of the push buttons
3. Connect the power supply (yellow and red LEDs flash simultaneously for 5 seconds, followed by the yellow and green LEDs flashing simultaneously)
4. Release the push button

The sensor will now function with the original factory settings.

Factory settings

See technical data.

Indication

Indicators

The sensor has four LEDs for indicating the status and two buttons for setting parameters.

	LED, green	LED L1, yellow	LED L2, yellow	LED, red
In normal mode Error-free operation Fault (e.g. compressed air)	On Off	The output status retains the last status	The output status retains the last status	Off On
When programming the switching points or trip values Object detected No object detected Confirmation, programming successful Warning, programming invalid	Off Off Flashes 3x Off	Flashes Off Off Off	Flashes Off Off Off	Off Flashes Off Flashes 3x
When programming the operating mode Programming the output mode Programming the output behavior Programming the sound cone	Flashes Off Off	Off Flashes Off	Off Flashes Off	Off Off Flashes

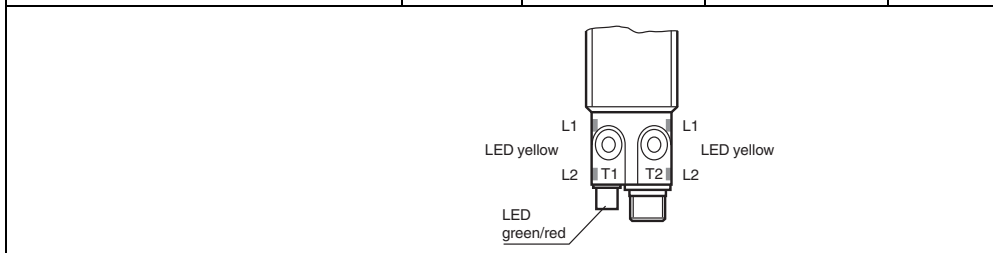

Commissioning

Synchronization

The sensor is fitted with a synchronization input that suppresses mutual interference from external ultrasonic signals. If this input is not connected, the sensor operates with internally generated cycle pulses. The sensor can be synchronized by creating external rectangular pulses and by setting the appropriate parameters via the IO-link interface. Each falling pulse edge sends an individual ultrasonic pulse. If the signal at the synchronization input is low for ≥ 1 second, the sensor reverts to the normal, unsynchronized operating mode. This also occurs if the synchronization input is disconnected from external signals (see note below).

If a high signal is applied to the synchronization input for > 1 second, the sensor switches to standby. This is indicated by the green LED. In this operating mode, the last recorded output statuses are retained. Please observe the software description in the event of external synchronization.

Note:

- If the option of synchronizing is not used, the synchronization input must be connected to ground (L-) or the sensor must be operated with a V1-connection cable (4-pin).
- During an active IO-Link communication the synchronization option is not available.

Release date: 2025-06-12 Date of issue: 2025-06-15 Filename: 191238_eng.pdf

The following synchronization modes are available:

1. Multiple sensors (see Technical data for the maximum number) can be synchronized by connecting the synchronization inputs on the sensors. In this case, the sensors synchronize themselves in succession in multiplex mode. Only one sensor sends signals at any one time. (See note below)
2. Multiple sensors (see Technical data for the maximum number) can be synchronized by connecting the synchronization inputs on the sensors. The sensor interface can be used to parameterize the sensors so that one functions as a master and the others function as slaves. (See interface description) In this case, the sensors in master/slave mode work simultaneously, i.e. in synchronization where the master sensor plays the role of an intelligent external impulse generator.
3. Multiple sensors can be controlled collectively by an external signal. In this case, the sensors are triggered in parallel and operate synchronously, i.e. at the same time. All sensors must be parameterized via the sensor interface so that they are set to external. See the software description.
4. Several sensors are controlled with a time delay by an external signal. In this case, only one sensor is externally synchronized at any one time (see note below). All sensors must be parameterized via the sensor interface so that they are set to external. See the software description.
5. A high signal (L+) or a low signal (L-) at the synchronization input switches the sensor to standby in the case of external parameterization.

Note:

The response time of the sensors increases in proportion to the number of sensors in the synchronization chain. In multiplex mode, the measuring cycles of the individual sensors run in succession in a chronological sequence.

Note:

The synchronization connection of the sensors supplies an output current in the case of a low signal, and generates an input impedance in the case of a high signal. Please note that the synchronizing device must have the following driver properties:

Driver current according to $L+ \geq n \cdot \text{high level signal/input impedance}$ (n = number of sensors to be synchronized)

Driver current according to $L- \geq n \cdot \text{output current}$ (n = number of sensors to be synchronized).