



Inductive sensor NBB10-30GK50-E2-30M

- With increased sealing, protection class IP68 / IP69K



Dimensions

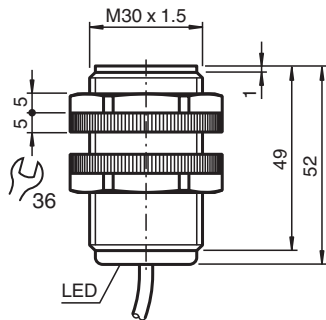

Technical Data

General specifications		
Switching function		Normally open (NO)
Output type		PNP
Rated operating distance	s_n	10 mm
Installation		flush
Output polarity		DC
Assured operating distance	s_a	0 ... 8.1 mm
Reduction factor r_{Al}		0.3
Reduction factor r_{Cu}		0.3
Reduction factor r_{304}		0.8
Output type		3-wire
Nominal ratings		
Operating voltage	U_B	10 ... 30 V
Switching frequency	f	0 ... 200 Hz
Reverse polarity protection		reverse polarity protected
Short-circuit protection		pulsing
Voltage drop	U_d	≤ 3 V

Release date: 2025-02-27 Date of issue: 2025-02-28 Filename: 191543_eng.pdf

Technical Data

Operating current	I_L	0 ... 200 mA
No-load supply current	I_0	≤ 20 mA
Switching state indicator		all direction LED, yellow
Functional safety related parameters		
MTTF _d		2062 a
Mission Time (T _M)		20 a
Diagnostic Coverage (DC)		0 %
Compliance with standards and directives		
Standard conformity		
Standards		EN IEC 60947-5-2
Approvals and certificates		
UL approval		cULus Listed, General Purpose
CCC approval		CCC approval / marking not required for products rated ≤ 36 V
Ambient conditions		
Ambient temperature		-25 ... 70 °C (-13 ... 158 °F)
Mechanical specifications		
Connection type		cable
Housing material		PBT
Sensing face		PBT
Degree of protection		IP68 / IP69K
Cable		
Wire end ferrules		yes
Cable diameter		4.6 mm \pm 0.2 mm
Bending radius		> 10 x cable diameter
Material		PVC
Color		grey
Number of cores		3
Core cross section		0.34 mm ²
Length	L	30 m
Dimensions		
Length		50 mm
Diameter		30 mm
Note		use only delivered nuts

Connection

