

Active infrared scanner

TopScan-S-M3S/L900

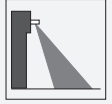

- Moving presence sensor for swing doors
- Configurable for a wide range of door leaf widths
- Category 2, tested and certified to DIN 18650/EN 16005
- Modular construction with master/slave modules
- Safe function even on difficult floors
- Each beam can be adjusted individually
- Easy adjustment of transmitter for hinge side/ opposite hinge side
- Four-beam version

Single or multi-beam light curtain for individual protection according to DIN 18650/EN16005



Function

The TopScan-S is a presence sensor for automatic revolving doors that operates according to the active infrared principle in background evaluation, and can be installed for mobile use in addition to static use. The modular structure consisting of master and slave modules means that the systems can be configured for different door panel widths up to 1400 mm. Up to 7 individually adjustable beams can be used in one device. This ensures test object detection across the entire door width. The sensors are certified according to the current DIN 18650/EN 16005 standard and, in conjunction with an appropriate, safe controller, fulfill all requirements for testable active opto-electronic protective devices (AOPDs) in Category 2.

Application

- Protection mechanism for closing edges on automatic doors
- Anti-collision protection for people/objects in the vicinity of revolving or carousel doors

Dimensions

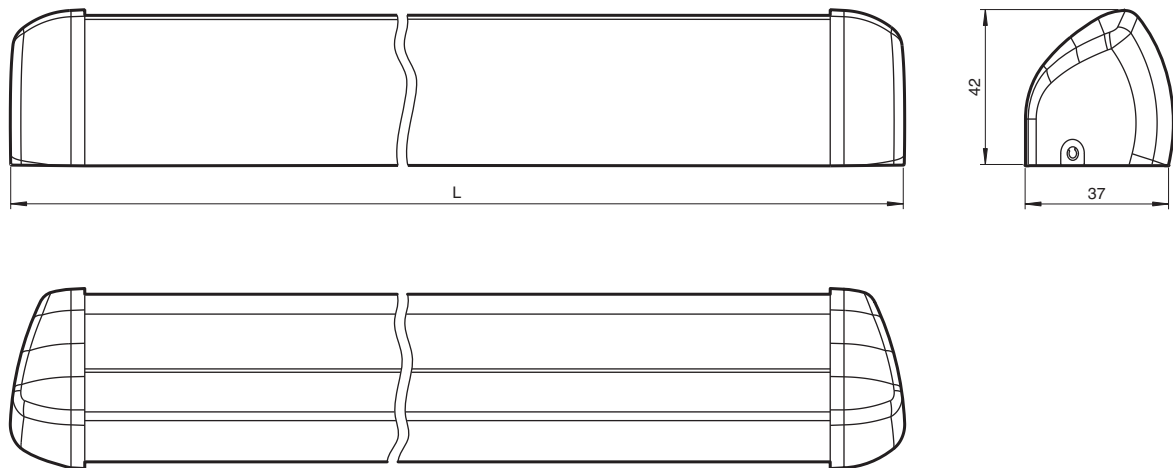

Technical Data

General specifications

Detection range min.	0 ... 1500 mm
Detection range max.	0 ... 2500 mm
Reference target	Minimum degree of reflection of the floor: 6 % Minimum degree of reflection to objects being detected: 0 %
Light source	IRED
Light type	modulated infrared light 875 nm
Black-white difference (6 %/90 %)	< 2 % at 2000 mm sensor range
Number of beams	4 (number of built-in sensor modules AIR)
Operating mode	Background evaluation
Diameter of the light spot	1.1 cm x 8.3 cm at 2000 mm sensor range
Resolution	Reference object CA DIN 186850-1/EN 16005 in all applicable locations

Functional safety related parameters

Safety Integrity Level (SIL)	SIL 1
Performance level (PL)	PL c
Category	Cat. 2
MTTF _d	880 a per module
Mission Time (T _M)	20 a
Diagnostic Coverage (DC)	90 %

Indicators/operating means

Function indicator	LED red/green
Control elements	Sensing range adjuster ; Adjuster for edge monitoring left/right

Technical Data

Electrical specifications		
Operating voltage	U_B	24 V DC +/- 20 %
No-load supply current	I_0	270 mA
Input		
Test input		active at $U = 11$ V DC at 30 V DC inactive at $U = -3$ V DC at 5 V DC
Output		
Switching type		Relay de-energized at object inside the scanning range
Signal output		Relay, 1 alternator
Switching voltage		5 V ... 30 V AC/DC
Switching current		max. 300 mA
Response time		≤ 70 ms
Conformity		
Functional safety		ISO 13849-1
Product standard		EN 12978 ; EN 16005 ; DIN 18650
Approvals and certificates		
CCC approval		CCC approval / marking not required for products rated ≤36 V
TÜV approval		TÜV NORD
Ambient conditions		
Ambient temperature		-10 ... 50 °C (14 ... 122 °F)
Relative humidity		Humidity at 20 °C: < 90 % Humidity at 60 °C: < 50 %
Mechanical specifications		
Housing length L		900 mm
Mounting height		max. 2500 mm
Degree of protection		IP52 , IP54 Optional (with special seal)
Connection		screw terminals ; Cable cross-section 0.3 mm ² ... 1.3 mm ² (AWG26-16), single-stranded/multistranded CU
Material		
Housing		aluminum / ABS
Optical face		PMMA
Cable length		max. 30 m
Note		Safety fuse ≤ 1 A (slow-blow) according to IEC 60127-2 Sheet 1 Recommendation: after a short circuit, check that the device is functioning correctly.

Assembly

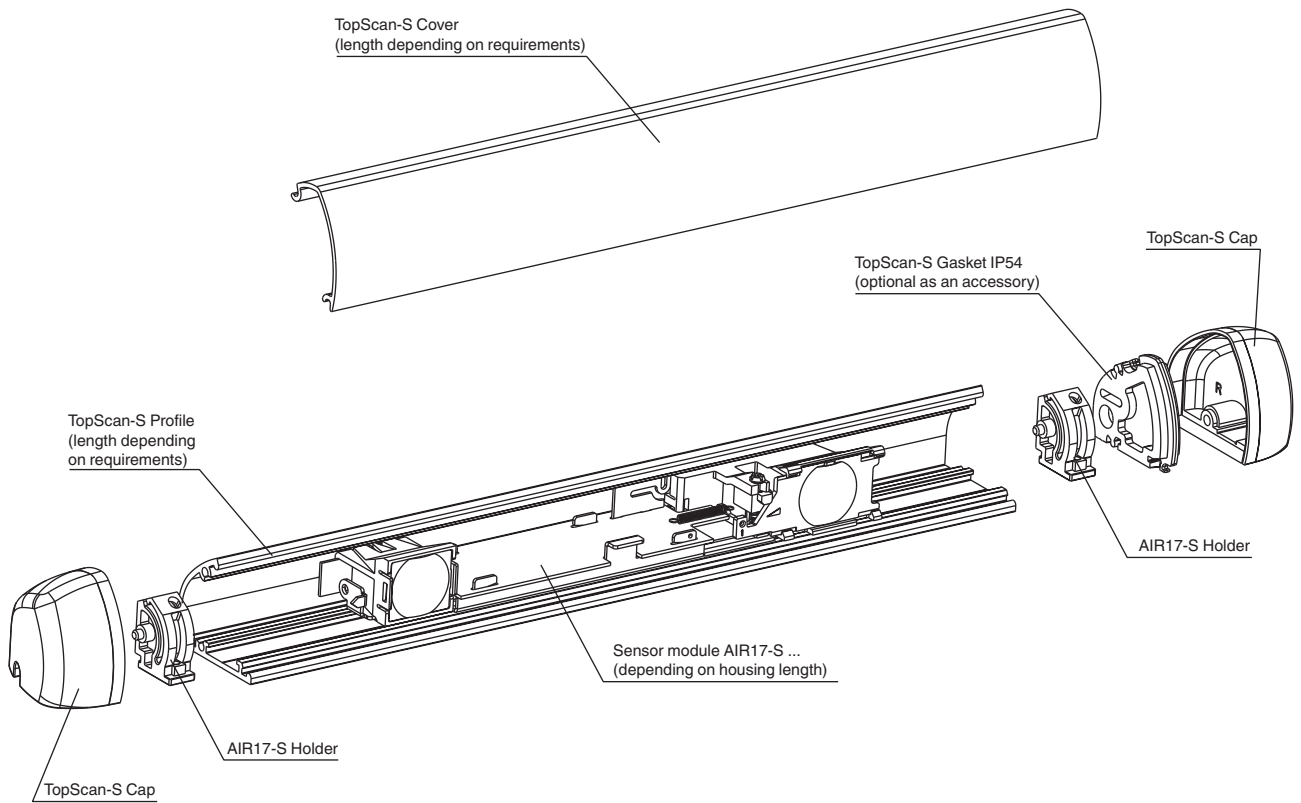

Connection Assignment

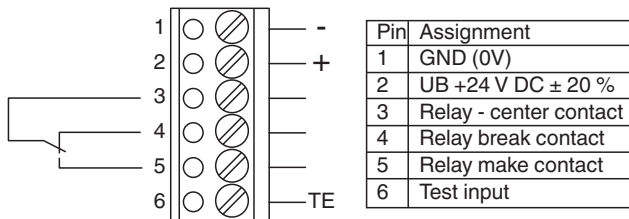

Explanation:

Relay:

Relay is inactive during detection

Relay is active in free detection field

Test input:

Test input is inactive at: U_{low} = -3 V ... +5 V DC

Test input is active at: U_{high} = +11 V ... +30 V DC

Release date: 2022-07-15 Date of issue: 2022-07-15 Filename: 193041_eng.pdf

Indication

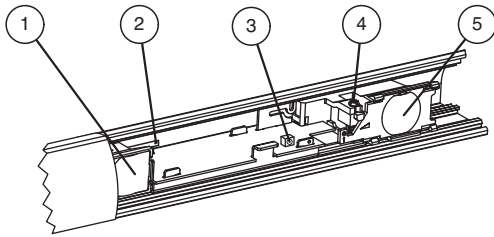





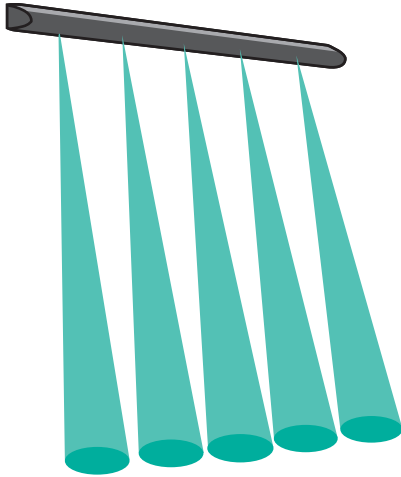





1	Emitter
2	Changeover switch adjuster, left/right
3	Function display
4	Detection range adjuster
5	Receiver

Application



Accessories

	DoorScan Weather Cap L1200	All-weather hood for DoorScan® and TopScan series sensing strips
	AIR17-S Master	Replacement/extension sensor module
	AIR17-S Slave	Replacement/extension sensor module
	TopScan-S Profile L1400	Housing profile TopScan-S
	TopScan-S Cover L1400	Housing cover TopScan-S
	TopScan-S Cap Set	End cover for TopScan-S aluminum profile section
	TopScan-S Gasket IP54	Housing seal TopScan-S
	AIR 16 S Einclipsbar Set	Bearing block for AIR17-S sensor module for installation in TopScan-S profile section
	TopScan-S Cable Loop Basic	Metal cable protector
	TopScan-S Test Kit	Adjustment accessories TopScan-S

Accessories

	TopScan-S Cable 240 mm	Ribbon cable for connecting sensor modules
---	-------------------------------	--

Maintenance

Test

If you use the TopScan-S as a protective device, the device must be tested at regular intervals by the door controller. Only perform the test if no object is detected. We recommend performing the test before each movement of the door. Connect the door controller test signal to the master module via the 6-pin screw terminal (Pin6).

Test sequence:

Time t_0 : The door controller activates the test request.

Time t_1 : Following a switch-on delay of 70 ms max., the sensor must switch to detection mode.

Time t_2 : After 200 ms, the sensor must still be in detection mode.

After this point, the test request from the door controller can be canceled.

This action ends the test and the sensor is available again after about 70 ms.

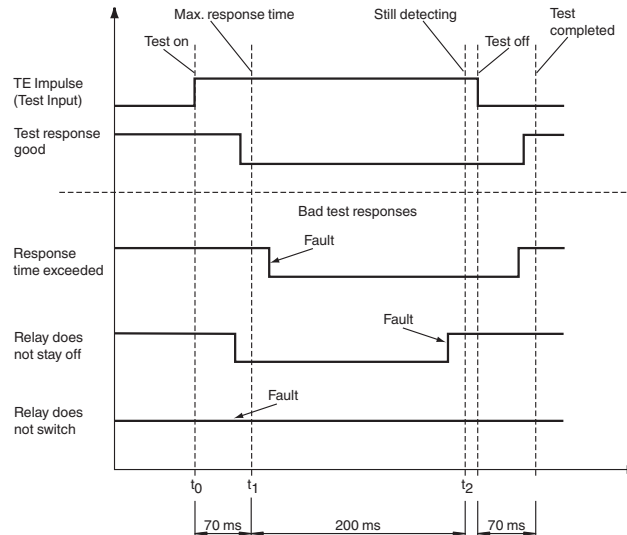

The door controller must query the sensor at times t_1 and t_2 .

The interior and exterior sides of the door must be switched on and off alternately (muting) -> and/or removed from the evaluation by the door controller.

Example:

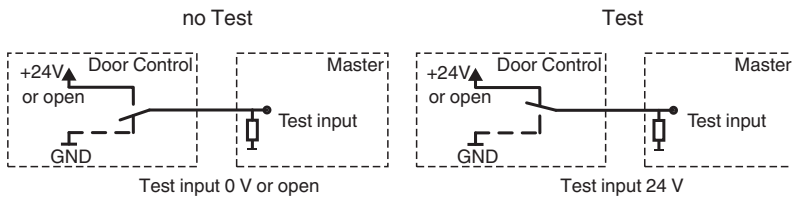

If the device is not used as a safety sensor in accordance with DIN 18650, there is no need to connect the test input.

Additional Information

Detection Area

Depending on requirements and the door width, a master module can be extended with up to seven slave modules.

We recommend that the straight transmitter/receiver beam of the relevant sensor module be mounted no further than 10 cm from the closing edge.

Mounting notes regarding different door widths can be found in the following illustration.

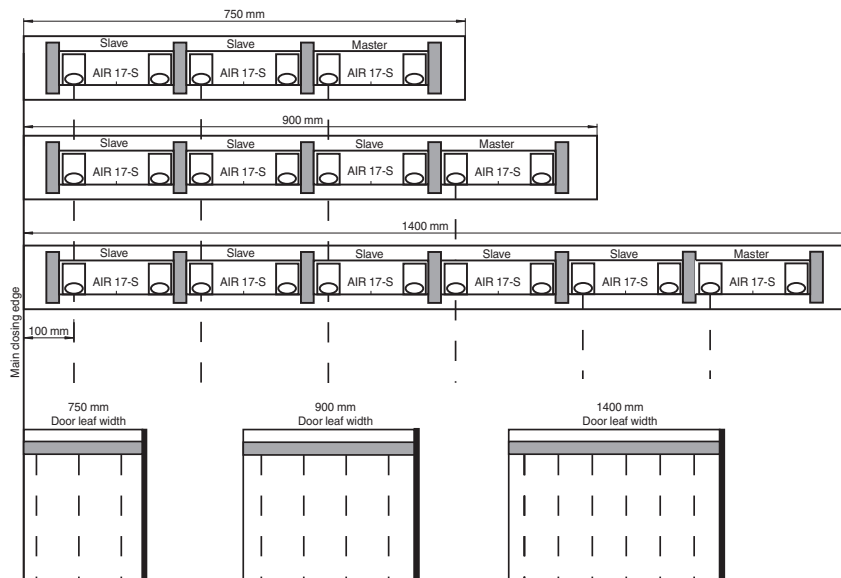

The wider the door, the more slave modules required.

Function principle

The TopScan-S is an active infrared triangulation sensor.

The device operates according to the active infrared principle in background evaluation mode, and is designed for installation on door panels for mobile use, in addition to static use. This makes the TopScan-S ideal for protection of closing edges on automatic revolving door panels. A sensor mounted directly on the door panel of a revolving door provides the best protection possible, as it always monitors the immediate vicinity in front of the current door panel position.

Construction

The TopScan-S consists of an aluminum profile with front panel, and can be adapted to different door widths up to 1400 mm as required. The profile is equipped with sensor modules and constructed according to the master/slave principle. A 900 mm door would require a master and three slaves for example, while a 7-beam system with master and six slaves represents the maximum version for a 1400 mm door.

Within the housing, there are multiple sensors that must be positioned according to specific application requirements.



The TopScan-S is intended for providing protection for automatic revolving doors according to DIN 18650 / EN 16005. When used as intended, the sensor should only be able to influence the movement of the door via the door controller rather than directly, as the combination of a safe door controller and a sensor is a prerequisite for the system to be considered a protective device according to EN ISO 13849-1, Performance Level "c" Category 2.



Modification of the construction/arrangement of the equipment without consulting the manufacturer could lead to hazardous situations.

Objects that enter the sensor's protection area are detected by infrared beams and cause the relay contact output to become disabled.

The light spot created on the floor by the infrared beam is approx. 1,1 cm x 8,3 cm large (at approx. 2 m installation height). The angle of the two lens systems can be changed by means of adjustment. This allows a detection range (detection height of objects) of up to 2.50 m max. to be set. The device is equipped with test objects for setting the detection range. The sensor reacts to objects in the detection range, largely irrespective of surface color and structure. Even reflective and extremely dark objects are detected.

Multiple sensors can be operated in a master/slave combination, in order to adapt the protection field to existing requirements. A 6-pin screw terminal is used to connect the master module with the door controller. The slave modules are connected to the master module by means of ribbon cable, and are also powered via the master module. The master module and slave module are located in the same aluminum profile.