



Model Number

V95-W-5M-PVC

Female cordset, 7/8", 5-pin, PVC cable

Features

- Self-locking threaded joint

Dimensions

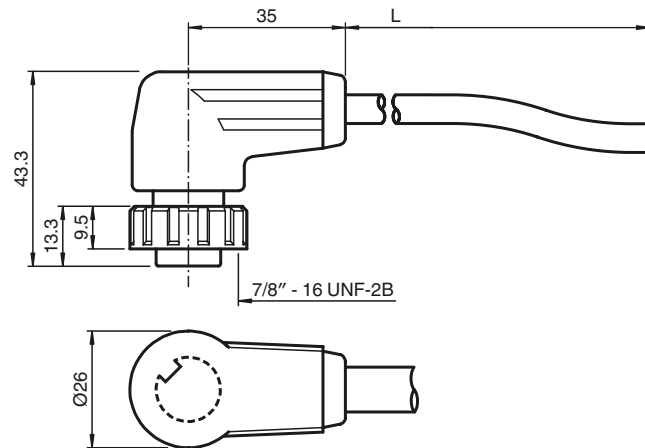

Technical data

General specifications

Number of pins	5
----------------	---

Electrical specifications

Operating voltage	U_B	max. 250 V AC/DC
Operating current	I_B	max. 9 A
Volume resistance		< 5 m Ω

Ambient conditions

Ambient temperature	5 ... 90 °C (41 ... 194 °F) active -40 ... 90 °C (-40 ... 194 °F) fixed
Pollution Degree	3

Mechanical specifications

Degree of protection	IP68 (2 hrs at 10 bar)
----------------------	------------------------

Material

Contacts	CuZn, silver-plated
Contact surface	Au
Body	TPU, orange
Cable	PVC
Slotted nut	PA

Cable

Sheath diameter	\varnothing 6.8 mm
Bending radius	> 5 x cable diameter, fixed > 10 x cable diameter, moving
Color	orange
Cores	5 x 0.5 mm ²
Conductor construction	16 x 0.2 mm \varnothing
Length	L 5 m

Electrical connection

