

# Universal Power Rail

## UPR-03-S

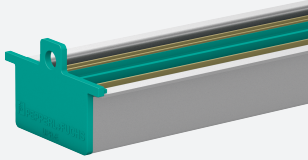

- 35 mm DIN mounting rail with 3-conductor insert
- Provides DC supply voltage to all equipped K-System modules
- Standard length 0.8 m (2.6 ft), simple to customize to application space
- Eliminates daisy-chains

Universal Power Rail with end caps and cover, 3 conductors, length: 0.8 m

### Function

The Power Rail consists of a DIN mounting rail UPR-MR and a insert UPR-INS-03. The component has two conductors for power and one conductor for collective error messaging. The component reduces wiring and maintenance costs because it eliminates the need to daisy-chain the wires. It also simplifies expansion – just snap in a new isolator when you're ready to expand a system. The component comes in 0.8 m segments but can be cut to any size. The Power Rail is delivered with two UPR-E end caps and UPR-COVER cover. All components of the Power Rail can be ordered separately. In conjunction with K-System modules the component can be mounted in Zone 2.

### Assembly

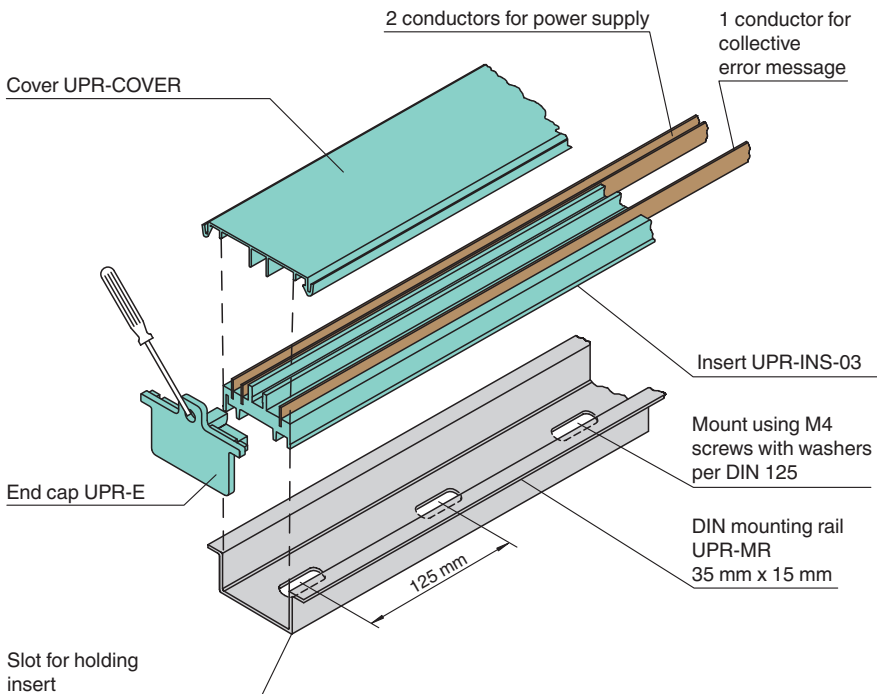

### Technical Data

#### Electrical specifications

Rated voltage	$U_r$	24 V DC
Rated current	$I_r$	4 A

Release date: 2023-05-24 Date of issue: 2023-05-24 Filename: 197007\_eng.pdf





## Technical Data

<b>Ambient conditions</b>		
Ambient temperature		-40 ... 70 °C (-40 ... 158 °F)
<b>Mechanical specifications</b>		
Connection		3 conductors
Supply		2 Conductors
Fault output		1 Conductors
Dimensions		35 x 15 x 800 mm (1.4 x 0.6 x 31.5 inch) (W x H x L)
<b>General information</b>		
Scope of delivery		- DIN mounting rail UPR-MR - insert UPR-INS-03 - cover UPR-COVER - end cap UPR-E

## Safety Information

Cover empty, open segments of the Power Rail. Use the supplied cover. Thereby Power Rail will be protected from pollution. The contact with electrically conductive parts on Power Rail will be prevented.

## Accessories

	<b>UPR-E</b>	End cap for universal power rail UPR-**-*
	<b>UPR-I</b>	Insulation spacer for universal power rail UPR-**-*
	<b>UPR-MR</b>	35 mm DIN mounting rail, length: 2 m (packaging unit: 2 pieces)
	<b>UPR-INS-03</b>	Insert for 35 mm DIN mounting rail
	<b>UPR-COVER</b>	Cover for 35 mm DIN mounting rail

Release date: 2023-05-24 Date of issue: 2023-05-24 Filename: 197007\_eng.pdf