

# Cable connector male, NAMUR V31S-W-N4-1M-PUR



- Suitable for NAMUR technology
- Degree of protection IP68
- Specific design protects against loosening and inaccurate installation

Male cordset single-ended M8 angled A-coded, 4-pin, PUR cable blue, NAMUR



## Dimensions

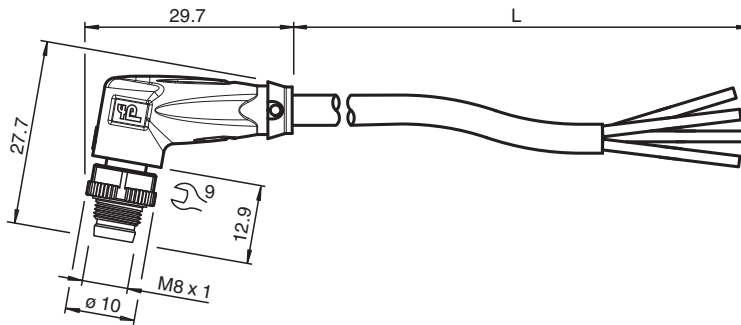

## Technical Data

General specifications		
Connector 1		
Connection		plug
Construction type		M8
Style		angled
Locking		screw connection
Number of pins		4
Coding		A-coded
Connector 2		
Connection		cable end
Electrical specifications		
Operating voltage	$U_B$	max. 30 V AC/DC
Operating current	$I_B$	3 A
Resistance per unit length	$R'$	max. 0.057 $\Omega/m$
Capacitance per unit length	$C'$	109 nF/km
Inductance per unit length	$L'$	0.49 mH/km
Conformity		
Degree of protection		EN 60529
Plug connection		connector M8 x 1 : IEC 61076-2-104
Ambient conditions		
Ambient temperature		

Release date: 2023-09-05 Date of issue: 2023-09-05 Filename: 200053\_eng.pdf

## Technical Data

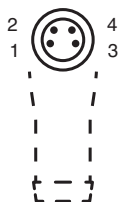

Plug connector		-40 ... 90 °C (-40 ... 194 °F)
Cable, fixed		-30 ... 80 °C (-22 ... 176 °F)
Cable, flexing		-10 ... 80 °C (14 ... 176 °F)
Pollution degree		3
<b>Mechanical specifications</b>		
Plug connector		
Tightening torque		0.4 Nm
Loosening protection		available
Tool installation		straight knurling and hexagon nut SW = 9 mm
Mating cycles		min. 100
Degree of protection		IP68
Cable		according to IEC/EN 60228 (DIN VDE 0295) class 6
Sheath diameter		4.8 mm
Bending radius		> 15 x cable diameter, moving > 10 x cable diameter, fixed
Sheath color		blue (similar to RAL 5015)
Number of cores		4
Core cross section		0.34 mm <sup>2</sup>
Cores color		Core 1: brown Core 2: white Core 3: blue Core 4: black
Core construction		42 x 0.1 mm Ø
Length	L	1 m
Cable code		Li FY 11Y 4 x 0.34
<b>Material</b>		
Plug connector		
Screw connection		Zinc diecast, nickel-plated
Body		TPU, black
Contact surface		gold plated (Au)
Flammability		V-2
Cable		
Sheathing		PUR based on polyether
Core insulation		PVC
Flammability		HB

## Connection





1	BN
2	WH
3	BU
4	BK

## Accessories

	<b>MH V3-SCREWDRIVER</b>	Torque screwdriver (0.4 Nm)
	<b>MH V3-BIT M8</b>	plug-in cap for M8

**Accessories**

	<b>V1/V3-LABELHOLDER</b>	Label holder
	<b>V1/V3-LABEL</b>	Label plate
	<b>MH V3-Holder</b>	Modular universal holder for M8 connectors