



Read head WCS2B-LS256

- RS-485 interface
- Non-contact, absolute position encoder
- Automatic detection of dirt accumulation

Read head, RS-485 interface, with RS-485 termination resistor



Dimensions

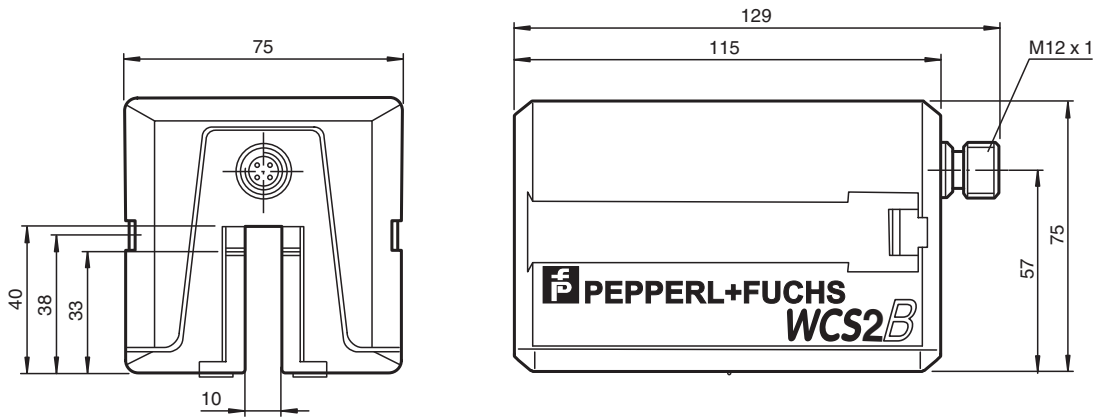

Dimensions

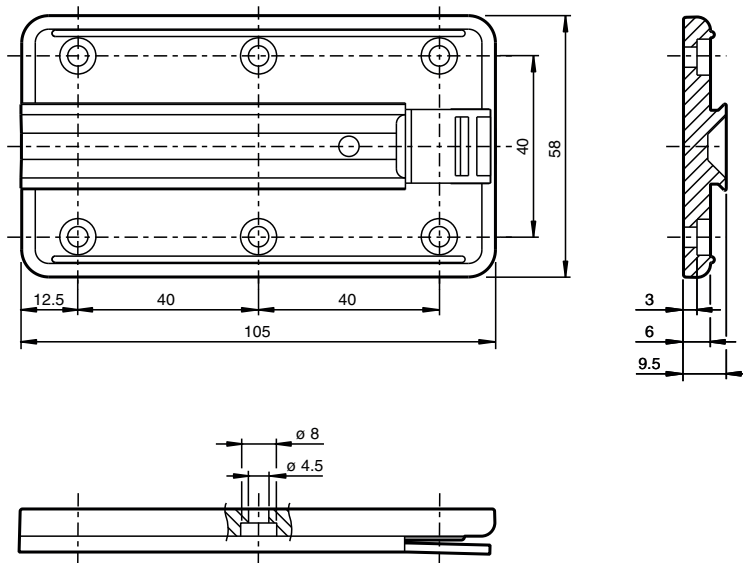

Technical Data

General specifications

Passage speed	v	≤ 12.5 m/s
Measuring range		max. 327 m
Free tolerances to code rail		horizontal: 10 mm (± 5 mm) vertical: 10 mm (± 5 mm)
Resolution		± 0.42 mm (1,200 positions/m)

Functional safety related parameters

MTTF _d		66 a
Mission Time (T _M)		10 a
Diagnostic Coverage (DC)		0 %

Electrical specifications

Operating voltage	U _B	10 ... 30 V DC
Power consumption	P ₀	2 VA

Interface

Interface type		RS 485 interface
Data output code		binary code
Protocol		3 , with Parity (9 Bit/Byte)
Transfer rate		9.6 kBit/s
Termination		with RS 485 termination

Standard conformity

Emitted interference		DIN EN 61000-6-4
Noise immunity		DIN EN 61000-6-2
Shock resistance		DIN EN 60068-2-27, half sine 30 g, 18 ms
Vibration resistance		DIN EN 60068-2-6, sine, 5 g, 10 - 2000 Hz, 10 cycles

Approvals and certificates

CSA approval		cCSAus Certified, General Purpose Class 2 power source
CCC approval		CCC approval / marking not required for products rated ≤36 V

Ambient conditions

Operating temperature		0 ... 60 °C (32 ... 140 °F)
-----------------------	--	-----------------------------

Technical Data

Storage temperature	-40 ... 85 °C (-40 ... 185 °F)
Relative humidity	90 % , noncondensing
Mechanical specifications	
Connection type	5-pin, M12 x 1 connector
Degree of protection	IP54
Material	
Housing	ABS , Polycarbonate , Polyamide (PA)
Mass	500 g
General information	
Ordering information	Mounting plate included with delivery

Connection

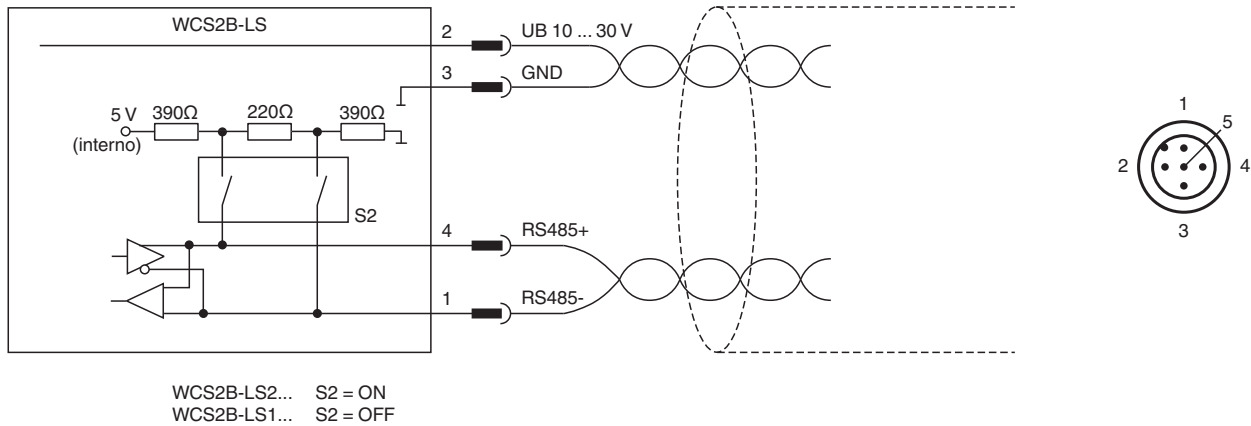

Accessories

	WCS-MP1	Mounting plate for reading heads WCS2 and WCS3
	WCS2-PL2	Transparent protective case and seal for WCS2 reader

Release date: 2023-01-09 Date of issue: 2023-01-09 Filename: 200779-0011_eng.pdf