



Inclination sensor

INY360D-F99-2I2E2-V17

- E1-Type approval
- Measuring range 0 ... 360°
- Analog output 4 mA ... 20 mA
- Evaluation limits can be taught-in
- 2 programmable switch outputs
- High shock resistance
- Increased noise immunity 100 V/m



Dimensions

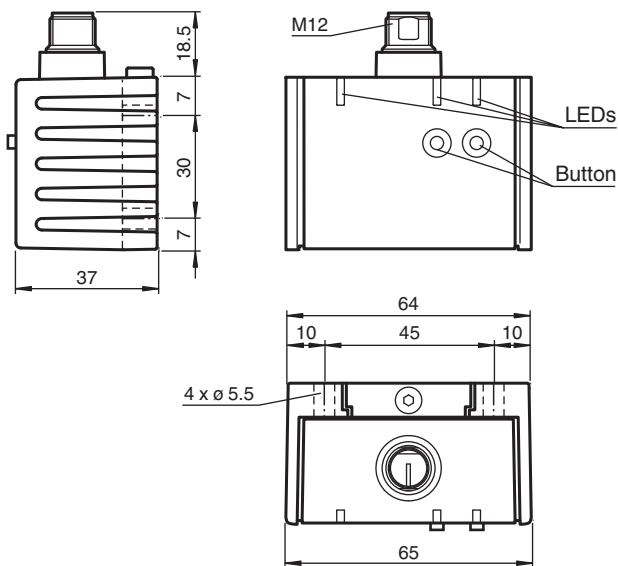

Technical Data

General specifications

Type	Inclination sensor, 2-axis
Measurement range	0 ... 360 °
Absolute accuracy	≤ ± 0.5 °
Response delay	≤ 25 ms
Resolution	≤ 0.1 °
Repeat accuracy	≤ ± 0.1 °
Temperature influence	≤ 0.027 °/K

Functional safety related parameters

Release date: 2020-04-24 Date of issue: 2020-06-03 Filename: 201501_eng.pdf

Technical Data

MTTF _d		300 a
Mission Time (T _M)		20 a
Diagnostic Coverage (DC)		0 %
Indicators/operating means		
Operation indicator		LED, green
Teach-In indicator		2 LEDs yellow (switching status), flashing
Button		2 push-buttons (Switch points programming , Evaluation range programming)
Switching state		2 yellow LEDs: Switching status (each output)
Electrical specifications		
Operating voltage	U _B	10 ... 30 V DC
No-load supply current	I ₀	≤ 25 mA
Time delay before availability	t _v	≤ 200 ms
Switching output		
Output type		2 switch outputs PNP, NO , reverse polarity protected , short-circuit protected
Operating current	I _L	≤ 100 mA
Voltage drop		≤ 3 V
Analog output		
Output type		2 current outputs 4 ... 20 mA (one output for each axis)
Load resistor		0 ... 200 Ω at U _B = 10 ... 18 V 0 ... 500 Ω at U _B = 18 ... 30 V
Compliance with standards and directives		
Standard conformity		
Shock and impact resistance		100 g according to DIN EN 60068-2-27
Standards		EN 60947-5-2:2007 IEC 60947-5-2:2007
Approvals and certificates		
UL approval		cULus Listed, Class 2 Power Source
E1 Type approval		10R-04
Ambient conditions		
Ambient temperature		-40 ... 85 °C (-40 ... 185 °F)
Storage temperature		-40 ... 85 °C (-40 ... 185 °F)
Mechanical specifications		
Connection type		8-pin, M12 x 1 connector
Housing material		PA
Degree of protection		IP68 / IP69K
Mass		240 g
Factory settings		
Analog output (X)		-45 ° ... 45 °
Analog output (Y)		-45 ° ... 45 °
Switching output (X)		-30 ° ... 30 °
Switching output (Y)		-30 ° ... 30 °

Connection

Standard symbol/Connection:

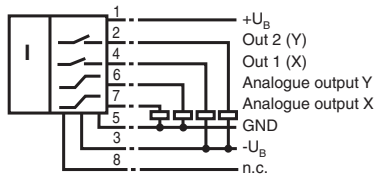

Connection Assignment

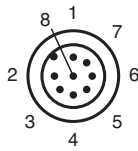

Wire colors

1	WH	(white)
2	BN	(brown)
3	GN	(green)
4	YE	(yellow)
5	GY	(gray)
6	PK	(pink)
7	BU	(blue)
8	RD	(red)

Accessories

	V17-G-2M-PUR	Female cordset, M12, 8-pin, shielded, PUR cable
	V17-G-5M-PUR	Female cordset, M12, 8-pin, shielded, PUR cable
	V17-G-10M-PUR	Female cordset, M12, 8-pin, shielded, PUR cable
	V17-G-10M-PVC-ABG	Female cordset, M12, 8-pin, shielded, PVC cable

Release date: 2020-04-24 Date of issue: 2020-06-03 Filename: 201501_eng.pdf

Mounting

Sensor Orientation

In the default setting the zero position of the sensor is reached, when the electrical connection faces straight upwards.

X Orientation

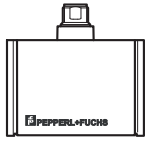

X = 0°

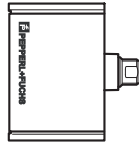

X = 90°



X = ±180°

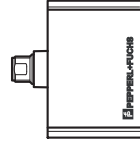

X = 270° (-90°)

Y Orientation



Y = 0°

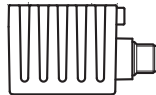

Y = 90°



Y = ±180°

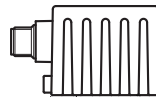

Y = 270° (-90°)

Mounting of the sensor

Sensors from the -F99 series consist of a sensor module and accompanying cast aluminum housing. Select a vertical surface with minimum dimensions of 70 mm x 50 mm to mount the sensor.

Mount the sensor as follows:

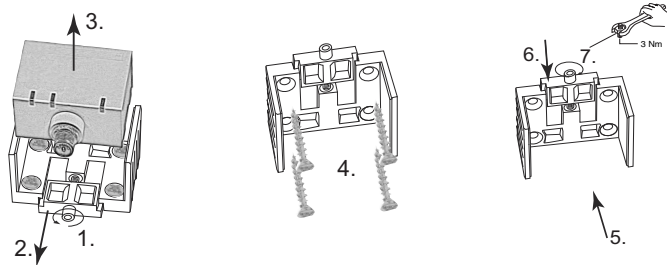

1. Loosen the central screw under the sensor connection.
 2. Slide back the clamping element until you are able to remove the sensor module from the housing.
 3. Remove the sensor module from the housing
 4. Position the housing at the required mounting location and secure using four countersunk screws. Make sure that the heads of the screws do not protrude.
 5. Place the sensor module in the housing.
 6. Slide the clamping element flush into the housing. Check that the sensor element is seated correctly.
 7. Finally tighten the central screw.
- The sensor is now mounted correctly.

Additional Information

LED display

Displays dependent on the operating state	LED green: Power	LED yellow out 1	LED yellow out 2
Teach-in of switching points (X-axis): Teach-in of switching points (Y-axis):	off off	flashes off	off flashes
Activate teach-in mode for analog limits: Teach-in of analog limit (X-axis) Teach-in of analog limit (Y-axis)	off off off	flashes flashes off	flashes off flashes
Normal operation	on	switchings tate	switchings tate
Reset to factory settings: 2 s ... 10 s > 10 s ... end of reset process Followed by normal operation	off flashes	flashes off	flashes off
Undervoltage	flashes	off	off

Axis definition

The definition of the X-axis and Y-axis is shown on the sensor housing by means of imprinted and labeled double arrows.

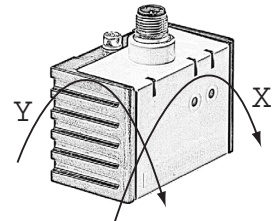

Teach-in of switching points (X-axis)

1. Press key T1 > 2 s (see LED display)
2. Move sensor to switching position 1
3. Press key T1 briefly. LED "out 1" lights for 1.5 s as confirmation. Switching point 1 has been taught
4. Move sensor to switching position 2
5. Press key T1 briefly. LED "out 1" lights for 1.5 s as confirmation. Switching point 2 has been taught
6. Sensor returns to normal operation (see LED display)



The NC (active output state) is always defined in the range from the 1st configured position to 2nd configured position.

As an example :

Case #1: configure position #1 at +45degree, configure position #2 at +90 degree; NC is from +45 ' +90 in the CW direction

Case #2: configure position #1 at +90degree ; configure position #2 at +45 degree; NC is from +90 ' +45 in the CW direction

Teach-in of switching points (Y-axis)

1. Press key T2 > 2 s (see LED display)
2. Move sensor to switching position 1
3. Press key T2 briefly. LED "out 2" lights for 1.5 s as confirmation. Switching point 1 has been taught
4. Move sensor to switching position 2
5. Press key T2 briefly. LED "out 2" lights for 1.5 s as confirmation. Switching point 2 has been taught
6. Sensor returns to normal operation (see LED display)



The NC (active output state) is always defined in the range from the 1st configured position to 2nd configured position.

See also the example, above.

Teach-in of analog limits (X-axis)

1. Activate the teach-in mode for the analog limits by simultaneously pressing keys T1 and T2 > 2 s (see LED display)
2. Press key T1 > for 2 s (see LED display)
3. Move the sensor into the position of minimum evaluation limit
4. Press key T1 briefly. LED "out 1" lights for 1.5 s as confirmation. The minimum evaluation limit has been taught. In this position the analog output will provide its minimum output value.
5. Move the sensor into the position of maximum evaluation limit
6. Press key T1 briefly. LED "out 1" lights for 1.5 s as confirmation. The maximum evaluation limit has been taught. In this position the analog output will provide its maximum output value.
7. Sensor returns to normal operation (see LED display)



If the sensor inclination exceeds one of the analog limits, the last value of the analog output is retained.

Teach-in of analog limits (Y-axis)

1. Activate the teach-in mode for the analog limits by simultaneously pressing keys T1 and T2 > 2 s (see LED display)
2. Press key T2 > 2 s (see LED display)
3. Move the sensor into the position of minimum evaluation limit
4. Press key T2 briefly. LED "out 2" lights for 1.5 s as confirmation. The minimum evaluation limit has been taught. In this position the analog output will provide its minimum output value.
5. Move the sensor into the position of maximum evaluation limit
6. Press key T2 briefly. LED "out 2" lights for 1.5 s as confirmation. The maximum evaluation limit has been taught. In this position the analog output will provide its maximum output value.
7. Sensor returns to normal operation (see LED display)



If the sensor inclination exceeds one of the analog limits, the last value of the analog output is retained.

Resetting the sensor to factory settings

1. Press keys T1 and T2 > 10 s (see LED display)
2. The sensor has been reset when the green LED "Power" lights again after approx. 10 s.

Release date: 2020-04-24 Date of issue: 2020-06-03 Filename: 201501_eng.pdf

Undervoltage detection

If the supply voltage falls below a value of approx. 7 V, all outputs and yellow LEDs are deactivated. The green "Power" LED flashes rapidly. If the supply voltage exceeds a value of approx. 8 V, the sensor continues with normal operation.

Technical Features

EMC Properties

Interference immunity in accordance with

DIN ISO 11452-2: 100 V/m

Frequency band 20 MHz up to 2 GHz

Mains-borne interference in accordance with ISO 7637-2:

Pulse	1	2	2	3	3	4
		a	b	a	b	
Severity level	I	I	I	I	I	I
	I	I	I	I	I	I
	I	I	I	I	I	I
Failure criterion	C	A	C	A	A	C
EN 61000-4-2:	CD: 8 kV		AD: 15 kV			
	/					
Severity level	IV		IV			
EN 61000-4-3:	30 V/m (80...2500 MHz)					
Severity level	IV					
EN 61000-4-4:	2 kV					
Severity level	III					
EN 61000-4-6:	10 V (0.01...80 MHz)					
Severity level	III					
EN 55011:	Klasse A					