



Inclination sensor

INY360D-F99-2I2E2-5M

- E1-Type approval
- Measuring range 0 ... 360°
- Analog output 4 mA ... 20 mA
- Evaluation limits can be taught-in
- 2 programmable switch outputs
- High shock resistance
- Increased noise immunity 100 V/m



Dimensions

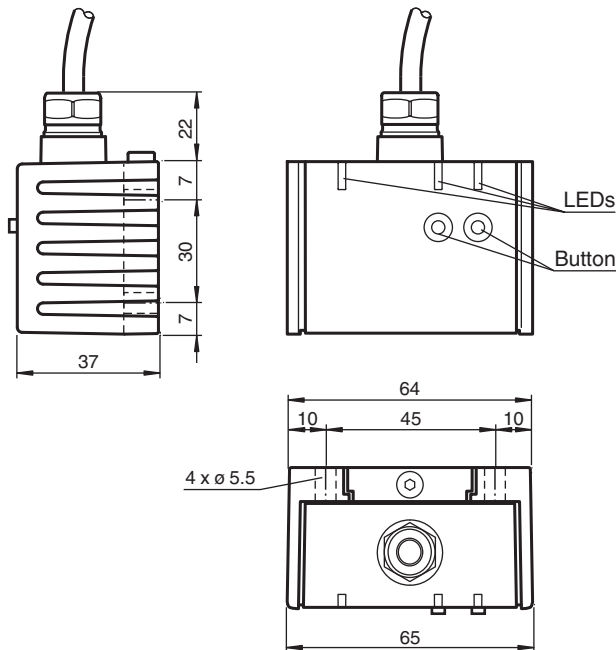

Technical Data

General specifications

| | |
|-----------------------|----------------------------|
| Type | Inclination sensor, 2-axis |
| Measurement range | 0 ... 360 ° |
| Absolute accuracy | ≤ ± 0.5 ° |
| Response delay | ≤ 25 ms |
| Resolution | ≤ 0.1 ° |
| Repeat accuracy | ≤ ± 0.1 ° |
| Temperature influence | ≤ 0.027 °/K |

Functional safety related parameters

Release date: 2020-04-24 Date of issue: 2020-06-03 Filename: 201502_eng.pdf

Technical Data

| | | |
|---|----------------|--|
| MTTF _d | | 300 a |
| Mission Time (T _M) | | 20 a |
| Diagnostic Coverage (DC) | | 0 % |
| Indicators/operating means | | |
| Operation indicator | | LED, green |
| Teach-In indicator | | 2 LEDs yellow (switching status), flashing |
| Button | | 2 push-buttons (Switch points programming , Evaluation range programming) |
| Switching state | | 2 yellow LEDs: Switching status (each output) |
| Electrical specifications | | |
| Operating voltage | U _B | 10 ... 30 V DC |
| No-load supply current | I ₀ | ≤ 25 mA |
| Time delay before availability | t _v | ≤ 200 ms |
| Switching output | | |
| Output type | | 2 switch outputs PNP, NO , reverse polarity protected , short-circuit protected |
| Operating current | I _L | ≤ 100 mA |
| Voltage drop | | ≤ 3 V |
| Analog output | | |
| Output type | | 2 current outputs 4 ... 20 mA (one output for each axis) |
| Load resistor | | 0 ... 200 Ω at U _B = 10 ... 18 V 0 ... 500 Ω at U _B = 18 ... 30 V |
| Compliance with standards and directives | | |
| Standard conformity | | |
| Shock and impact resistance | | 100 g according to DIN EN 60068-2-27 |
| Standards | | EN 60947-5-2:2007 IEC 60947-5-2:2007 |
| Approvals and certificates | | |
| UL approval | | cULus Listed, Class 2 Power Source |
| E1 Type approval | | 10R-04 |
| Ambient conditions | | |
| Ambient temperature | | -40 ... 85 °C (-40 ... 185 °F) |
| Storage temperature | | -40 ... 85 °C (-40 ... 185 °F) |
| Mechanical specifications | | |
| Connection type | | 5 m, PUR cable 7 x 0.5 mm ² |
| Housing material | | PA |
| Degree of protection | | IP68 / IP69K |
| Cable | | |
| Bending radius | | > 10 x cable diameter |
| Mass | | 240 g |
| Factory settings | | |
| Analog output (X) | | -45 ° ... 45 ° |
| Analog output (Y) | | -45 ° ... 45 ° |
| Switching output (X) | | -30 ° ... 30 ° |
| Switching output (Y) | | -30 ° ... 30 ° |

Connection

Standard symbol/Connection:

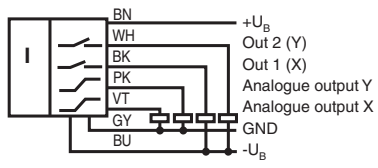

Mounting

Sensor Orientation

In the default setting the zero position of the sensor is reached, when the electrical connection faces straight upwards.

X Orientation

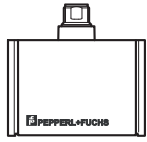

X = 0°

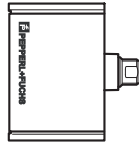

X = 90°



X = ±180°

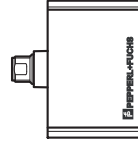

X = 270° (-90°)

Y Orientation



Y = 0°

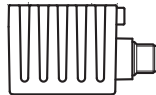

Y = 90°



Y = ±180°

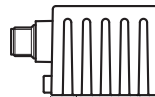

Y = 270° (-90°)

Mounting of the sensor

Sensors from the -F99 series consist of a sensor module and accompanying cast aluminum housing. Select a vertical surface with minimum dimensions of 70 mm x 50 mm to mount the sensor.

Mount the sensor as follows:

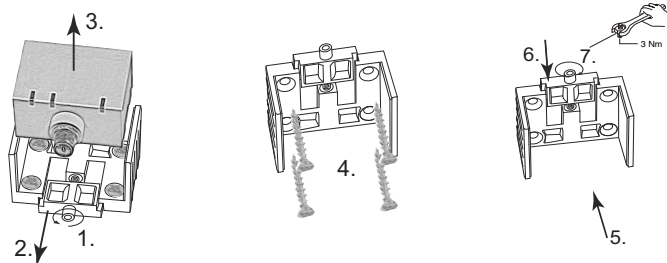

1. Loosen the central screw under the sensor connection.
 2. Slide back the clamping element until you are able to remove the sensor module from the housing.
 3. Remove the sensor module from the housing
 4. Position the housing at the required mounting location and secure using four countersunk screws. Make sure that the heads of the screws do not protrude.
 5. Place the sensor module in the housing.
 6. Slide the clamping element flush into the housing. Check that the sensor element is seated correctly.
 7. Finally tighten the central screw.
- The sensor is now mounted correctly.

Additional Information

LED display

| | | | |
|--|---------------------|---------------------------|---------------------------|
| Displays dependent on the operating state | LED green: Power | LED yellow out 1 | LED yellow out 2 |
| Teach-in of switching points (X-axis): Teach-in of switching points (Y-axis): | off off | flashes off | off flashes |
| Activate teach-in mode for analog limits: Teach-in of analog limit (X-axis) Teach-in of analog limit (Y-axis) | off off off | flashes flashes off | flashes off flashes |
| Normal operation | on | switchings tate | switchings tate |
| Reset to factory settings: 2 s ... 10 s > 10 s ... end of reset process Followed by normal operation | off flashes | flashes off | flashes off |
| Undervoltage | flashes | off | off |

Axis definition

The definition of the X-axis and Y-axis is shown on the sensor housing by means of imprinted and labeled double arrows.

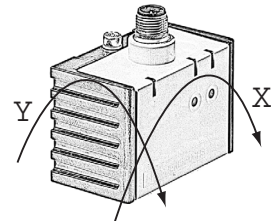

Teach-in of switching points (X-axis)

1. Press key T1 > 2 s (see LED display)
2. Move sensor to switching position 1
3. Press key T1 briefly. LED "out 1" lights for 1.5 s as confirmation. Switching point 1 has been taught
4. Move sensor to switching position 2
5. Press key T1 briefly. LED "out 1" lights for 1.5 s as confirmation. Switching point 2 has been taught
6. Sensor returns to normal operation (see LED display)



The NC (active output state) is always defined in the range from the 1st configured position to 2nd configured position.

As an example :

Case #1: configure position #1 at +45degree, configure position #2 at +90 degree; NC is from +45 ' +90 in the CW direction

Case #2: configure position #1 at +90degree ; configure position #2 at +45 degree; NC is from +90 ' +45 in the CW direction

Teach-in of switching points (Y-axis)

1. Press key T2 > 2 s (see LED display)
2. Move sensor to switching position 1
3. Press key T2 briefly. LED "out 2" lights for 1.5 s as confirmation. Switching point 1 has been taught
4. Move sensor to switching position 2
5. Press key T2 briefly. LED "out 2" lights for 1.5 s as confirmation. Switching point 2 has been taught
6. Sensor returns to normal operation (see LED display)



The NC (active output state) is always defined in the range from the 1st configured position to 2nd configured position.

See also the example, above.

Teach-in of analog limits (X-axis)

1. Activate the teach-in mode for the analog limits by simultaneously pressing keys T1 and T2 > 2 s (see LED display)
2. Press key T1 > for 2 s (see LED display)
3. Move the sensor into the position of minimum evaluation limit
4. Press key T1 briefly. LED "out 1" lights for 1.5 s as confirmation. The minimum evaluation limit has been taught. In this position the analog output will provide its minimum output value.
5. Move the sensor into the position of maximum evaluation limit
6. Press key T1 briefly. LED "out 1" lights for 1.5 s as confirmation. The maximum evaluation limit has been taught. In this position the analog output will provide its maximum output value.
7. Sensor returns to normal operation (see LED display)



If the sensor inclination exceeds one of the analog limits, the last value of the analog output is retained.

Teach-in of analog limits (Y-axis)

1. Activate the teach-in mode for the analog limits by simultaneously pressing keys T1 and T2 > 2 s (see LED display)
2. Press key T2 > 2 s (see LED display)
3. Move the sensor into the position of minimum evaluation limit
4. Press key T2 briefly. LED "out 2" lights for 1.5 s as confirmation. The minimum evaluation limit has been taught. In this position the analog output will provide its minimum output value.
5. Move the sensor into the position of maximum evaluation limit
6. Press key T2 briefly. LED "out 2" lights for 1.5 s as confirmation. The maximum evaluation limit has been taught. In this position the analog output will provide its maximum output value.
7. Sensor returns to normal operation (see LED display)



If the sensor inclination exceeds one of the analog limits, the last value of the analog output is retained.

Resetting the sensor to factory settings

1. Press keys T1 and T2 > 10 s (see LED display)
2. The sensor has been reset when the green LED "Power" lights again after approx. 10 s.

Release date: 2020-04-24 Date of issue: 2020-06-03 Filename: 201502_eng.pdf

Undervoltage detection

If the supply voltage falls below a value of approx. 7 V, all outputs and yellow LEDs are deactivated. The green "Power" LED flashes rapidly. If the supply voltage exceeds a value of approx. 8 V, the sensor continues with normal operation.

Technical Features

EMC Properties

Interference immunity in accordance with

DIN ISO 11452-2: 100 V/m

Frequency band 20 MHz up to 2 GHz

Mains-borne interference in accordance with ISO 7637-2:

| | | | | | | |
|-------------------|------------------------|---|-----------|---|---|---|
| Pulse | 1 | 2 | 2 | 3 | 3 | 4 |
| | | a | b | a | b | |
| Severity level | I | I | I | I | I | I |
| | I | I | I | I | I | I |
| | I | I | I | I | I | I |
| Failure criterion | C | A | C | A | A | C |
| EN 61000-4-2: | CD: 8 kV | | AD: 15 kV | | / | |
| Severity level | IV | | IV | | | |
| EN 61000-4-3: | 30 V/m (80...2500 MHz) | | | | | |
| Severity level | IV | | | | | |
| EN 61000-4-4: | 2 kV | | | | | |
| Severity level | III | | | | | |
| EN 61000-4-6: | 10 V (0.01...80 MHz) | | | | | |
| Severity level | III | | | | | |
| EN 55011: | Klasse A | | | | | |