



Retroreflective sensor

RLK31-54/25/31/33/115-5M



- Cost-optimized series for standard tasks
- Large construction with small housing
- Version for universal voltages
- Relay output

Retroreflective sensor with polarization filter, plastic housing, 9 m detection range, red light, light on, AC/DC version, relay contact output, no control elements, fixed cable



Dimensions

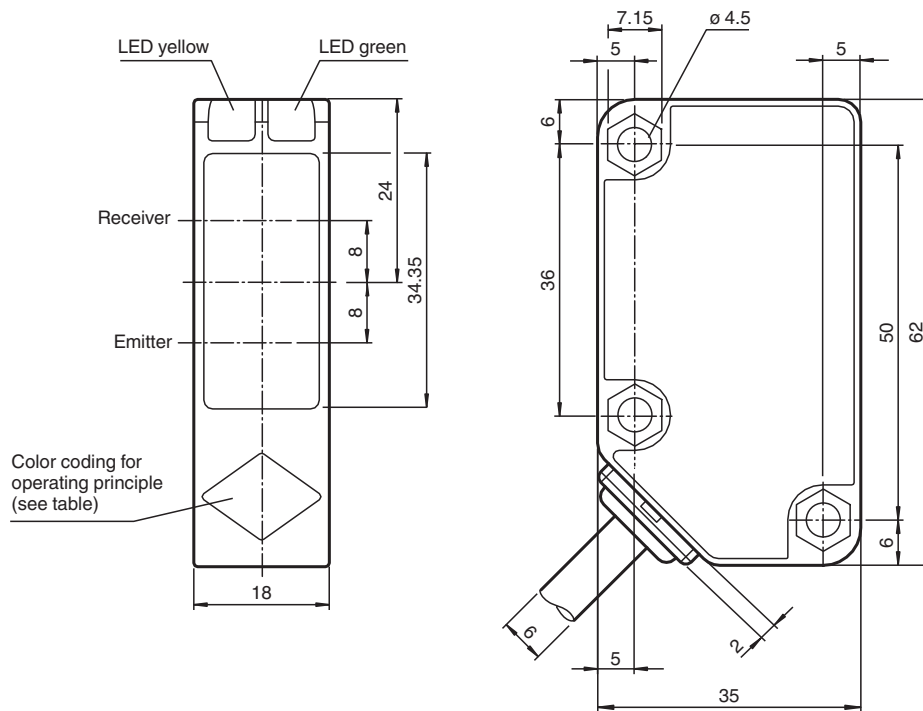

Operating principle	color
Retroreflective sensor with polarisation filter	green
Retroreflective sensor	blue
Diffusive mode sensor	white
Thru -beam sensor	grey
Diffusive mode sensor with background suppression	red

Technical Data

General specifications

Effective detection range 0 ... 9000 mm

Release date: 2023-12-28 Date of issue: 2023-12-28 Filename: 203405_eng.pdf

Technical Data

Reflector distance		20 ... 9000 mm
Threshold detection range		12 m
Reference target		reflector C110-2
Light source		LED
Light type		modulated visible red light , 630 nm
Polarization filter		yes
Diameter of the light spot		approx. 200 mm at a distance of 6 m
Opening angle		3 °
Ambient light limit		50000 Lux
Functional safety related parameters		
MTTF _d		790 a
Mission Time (T _M)		20 a
Diagnostic Coverage (DC)		0 %
Indicators/operating means		
Operation indicator		LED green: power on
Function indicator		LED yellow: 1. LED lit constantly: signal > 2 x switching point (function reserve) 2. LED flashes: signal between 1 x switching point and 2 x switching point 3. LED off: signal < switching point
Electrical specifications		
Operating voltage	U _B	24 ... 240 V AC 12 ... 240 V DC
No-load supply current	I ₀	≤ 40 mA
Power consumption	P ₀	≤ 2 VA
Output		
Switching type		light-on
Signal output		Relay, 1 alternator
Switching voltage		max. 240 V AC
Switching current		max. 3 A
Switching power		DC: max. 150 W AC: max. 750 VA
Switching frequency	f	20 Hz
Response time		≤ 25 ms
Conformity		
Product standard		EN 60947-5-2
Approvals and certificates		
Protection class		II , rated voltage ≤ 250 V AC with pollution degree 1-2 according to IEC 60664-1 Output circuit basis insulation of input circuit according to EN 50178, rated insulation voltage 240 V AC
CCC approval		Certified by China Compulsory Certification (CCC)
Ambient conditions		
Ambient temperature		-25 ... 55 °C (-13 ... 131 °F)
Storage temperature		-40 ... 70 °C (-40 ... 158 °F)
Mechanical specifications		
Degree of protection		IP67
Connection		5 m fixed cable
Material		
Housing		Polycarbonate
Optical face		PMMA
Mass		154 g
Dimensions		
Height		62 mm
Width		18 mm
Depth		35 mm

Connection Assignment

Option:

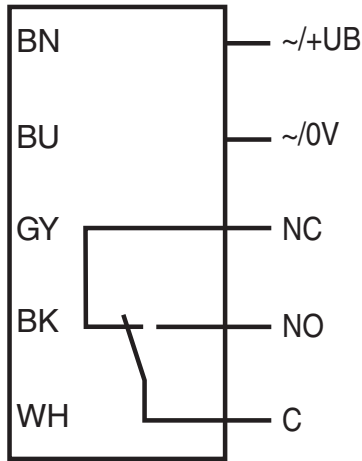

Characteristic Curve

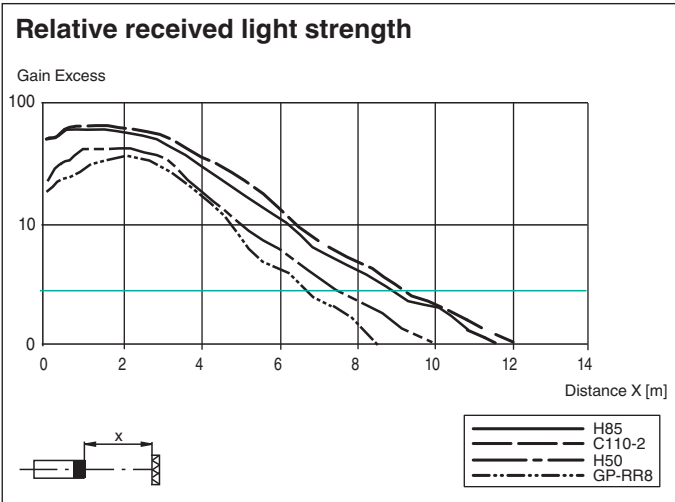
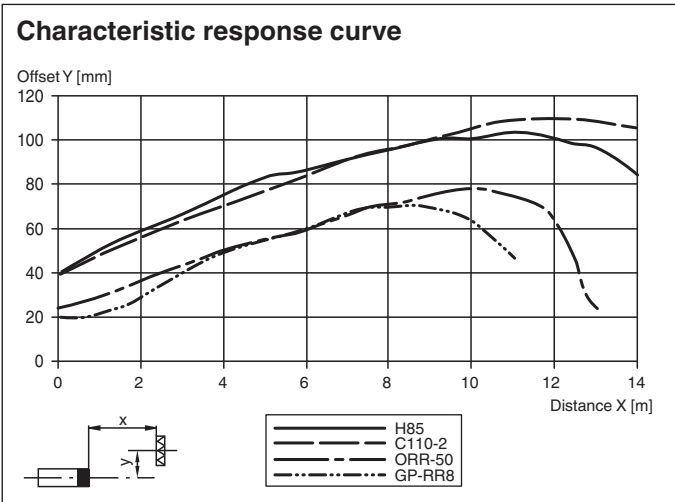

Release date: 2023-12-28 Date of issue: 2023-12-28 Filename: 203405_eng.pdf