



Diffuse mode sensor RL31-8-2500-IR/115/136



- Highly visible LED
- Powerful push-pull output
- Compact and stable housing
- Protection class II

Diffuse mode sensor, plastic housing, 2500 mm adjustable detection range, infrared light, light on, 2 push-pull outputs, fixed cable

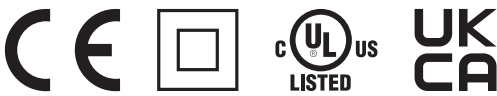

Dimensions

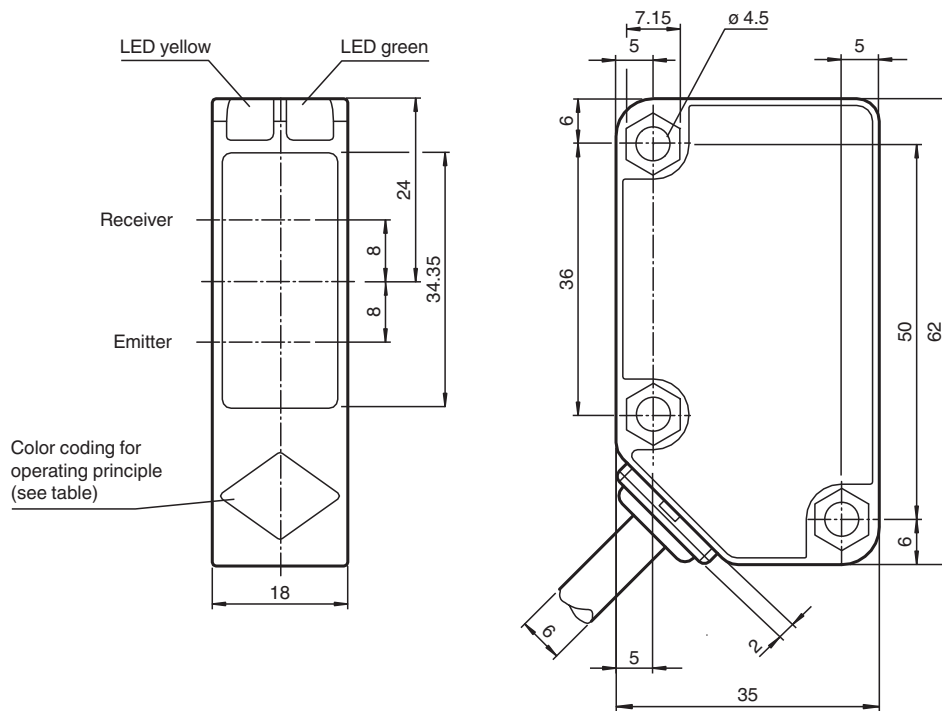

Operating principle	color
Retroreflective sensor	green
Retroreflective sensor without polarization filter	blue
Diffuse type sensor	white
Thru-beam sensor	grey
Convergent beam sensor	red

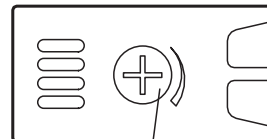

Sensing range adjustment

Technical Data

General specifications

Detection range 0 ... 2500 mm adjustable

Release date: 2023-10-13 Date of issue: 2023-10-13 Filename: 207545_eng.pdf

Technical Data

Reference target		standard white 200 mm 200 mm
Light source		IREd
Light type		modulated infrared light , 850 nm
Polarization filter		no
Diameter of the light spot		approx. 50 mm at a distance of 2.5 m
Opening angle		2 °
Ambient light limit		50000 Lux ; according to EN 60947-5-2
Functional safety related parameters		
MTTF _d		920 a
Mission Time (T _M)		20 a
Diagnostic Coverage (DC)		0 %
Indicators/operating means		
Operation indicator		LED green: power on
Function indicator		LED yellow, lights up with receiver lit
Control elements		Sensing range adjuster
Electrical specifications		
Operating voltage	U _B	10 ... 30 V DC , class 2
Ripple		10 %
No-load supply current	I ₀	≤ 20 mA
Output		
Switching type		light-on
Signal output		2 push-pull (4 in 1) outputs, short-circuit protected, reverse polarity protected
Switching voltage		max. 30 V DC
Switching current		max. 100 mA
Voltage drop	U _d	≤ 1.5 V
Switching frequency	f	≤ 500 Hz
Response time		≤ 1 ms
Conformity		
Product standard		EN 60947-5-2
Approvals and certificates		
Protection class		II , rated insulation voltage ≤ 250 V AC with pollution degree 1-2 according to IEC 60664-1 Output circuit basis insulation of input circuit according to EN 50178, rated insulation voltage 240 V AC
UL approval		cULus Listed, Class 2 Power Source, Type 1 enclosure
CCC approval		CCC approval / marking not required for products rated ≤36 V
Ambient conditions		
Ambient temperature		-30 ... 55 °C (-22 ... 131 °F)
Storage temperature		-40 ... 70 °C (-40 ... 158 °F)
Mechanical specifications		
Housing width		18 mm
Housing height		62 mm
Housing depth		35 mm
Degree of protection		IP67
Connection		2 m fixed cable , 4-wire
Material		
Housing		Polycarbonate
Optical face		PMMA
Mass		133 g

Connection Assignment

Option:

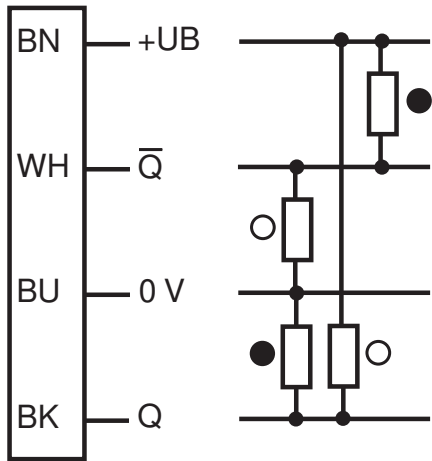

○ = Light on
● = Dark on

Assembly

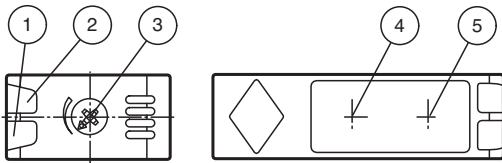

1	Operating display	green
2	Signal display	yellow
3	Sensing range adjuster	
4	Emitter	
5	Receiver	

Characteristic Curve

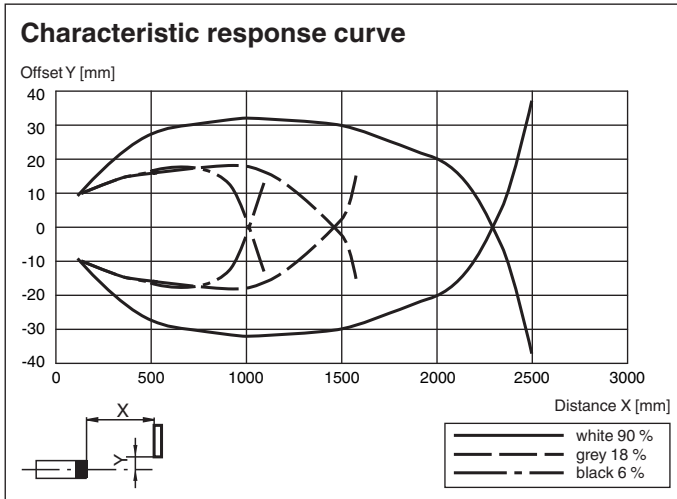





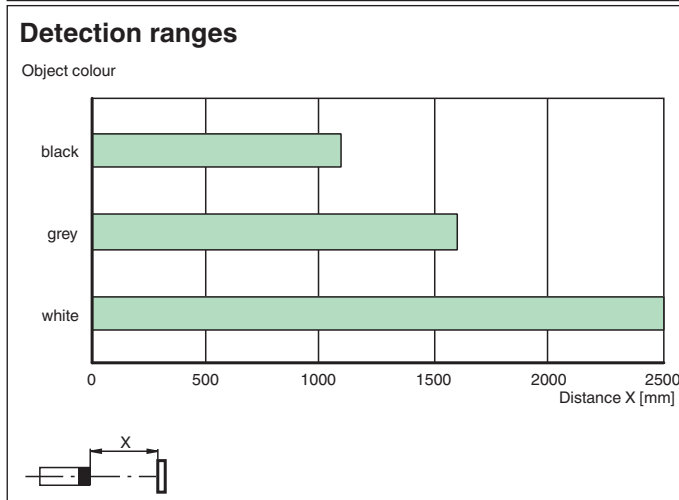
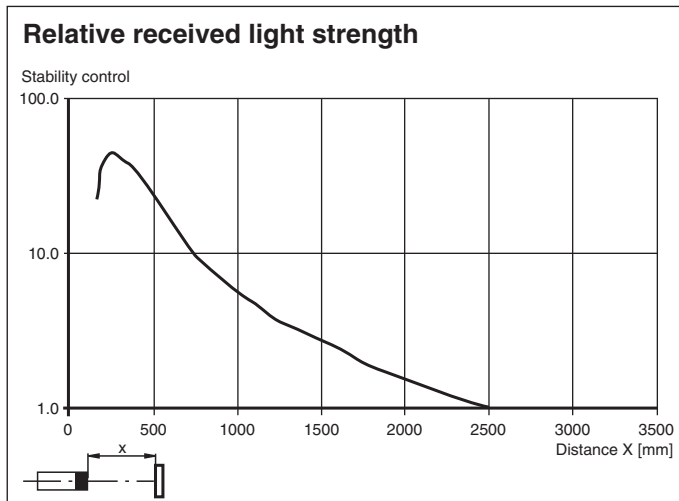

Release date: 2023-10-13 Date of issue: 2023-10-13 Filename: 207545_eng.pdf

Characteristic Curve



Accessories

	OMH-RL31-01	Mounting bracket
	OMH-RL31-02	Mounting bracket narrow
	OMH-RL31-03	Mounting bracket narrow
	OMH-RL31-04	Mounting aid for round steel \varnothing 12 mm or sheet 1.5 mm ... 3 mm
	OMH-RL31-05	Mounting bracket for mounting on flat surfaces with 2 M4 screws
	OMH-RL31-06	Stainless steel mounting bracket with adjustable half clamp on the side