



Inclination sensor INX360D-F99-I2E2-7M

- E1-Type approval
- Measuring range 0 ... 360°
- Analog output 4 mA ... 20 mA
- Evaluation limits can be taught-in
- 2 programmable switch outputs
- High shock resistance
- Increased noise immunity 100 V/m



Dimensions

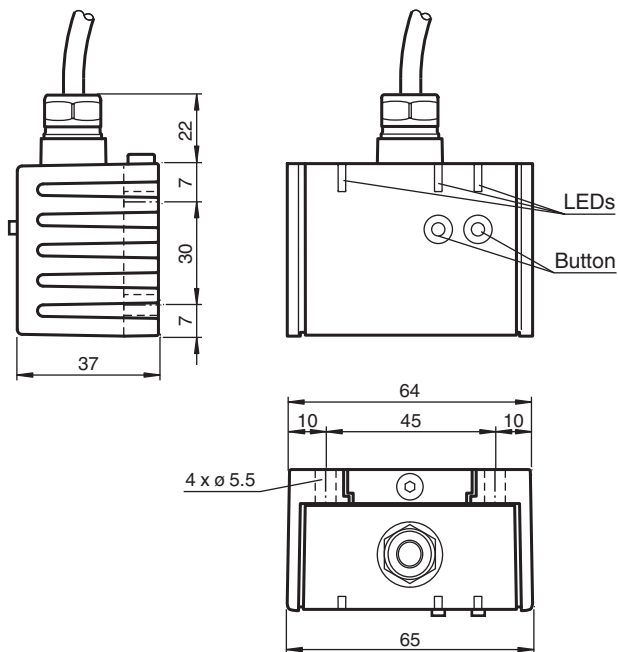

Technical Data

General specifications

Type	Inclination sensor, 1-axis
Measurement range	0 ... 360 °
Absolute accuracy	$\leq \pm 0.5$ °
Response delay	≤ 20 ms
Resolution	≤ 0.1 °
Repeat accuracy	$\leq \pm 0.1$ °
Temperature influence	≤ 0.027 °/K

Functional safety related parameters

Technical Data

MTTF _d		300 a
Mission Time (T _M)		20 a
Diagnostic Coverage (DC)		0 %
Indicators/operating means		
Operation indicator		LED, green
Teach-In indicator		2 LEDs yellow (switching status), flashing
Button		2 push-buttons (Switch points programming , Evaluation range programming)
Switching state		2 yellow LEDs: Switching status (each output)
Electrical specifications		
Operating voltage	U _B	10 ... 30 V DC
No-load supply current	I ₀	≤ 25 mA
Time delay before availability	t _v	≤ 200 ms
Switching output		
Output type		2 switch outputs PNP, NO , reverse polarity protected , short-circuit protected
Operating current	I _L	≤ 100 mA
Voltage drop		≤ 3 V
Analog output		
Output type		1 current output 4 ... 20 mA
Load resistor		0 ... 200 Ω at U _B = 10 ... 18 V 0 ... 500 Ω at U _B = 18 ... 30 V
Compliance with standards and directives		
Standard conformity		
Shock and impact resistance		100 g according to DIN EN 60068-2-27
Standards		EN 60947-5-2:2007 IEC 60947-5-2:2007
Approvals and certificates		
UL approval		cULus Listed, Class 2 Power Source
CCC approval		CCC approval / marking not required for products rated ≤36 V
E1 Type approval		10R-04
Ambient conditions		
Ambient temperature		-40 ... 85 °C (-40 ... 185 °F)
Storage temperature		-40 ... 85 °C (-40 ... 185 °F)
Mechanical specifications		
Connection type		7 m, PUR cable 5 x 0.5 mm ²
Housing material		PA
Degree of protection		IP68 / IP69K
Mass		240 g
Factory settings		
Switching output 1		-30 ° ... 30 °
Switching output 2		-30 ° ... 30 °
Analog output		-45 ° ... 45 °

Connection

Standard symbol/Connection:

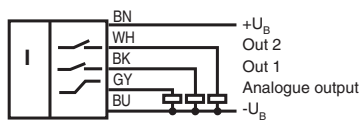

Mounting

Sensor Orientation

In the default setting the zero position of the sensor is reached, when the electrical connection faces straight upwards.

X Orientation

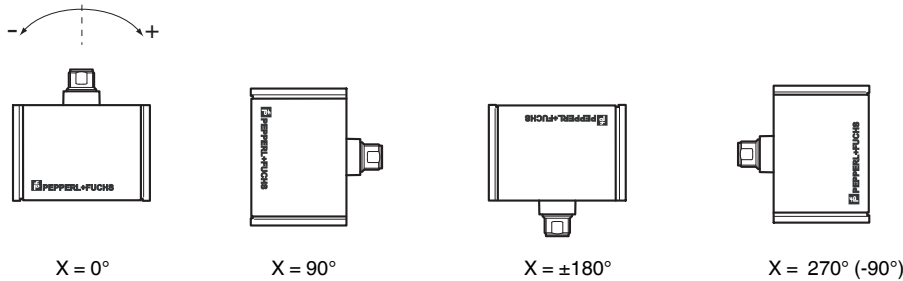

Mounting of the sensor

Sensors from the -F99 series consist of a sensor module and accompanying cast aluminum housing. Select a vertical surface with minimum dimensions of 70 mm x 50 mm to mount the sensor.

Mount the sensor as follows:

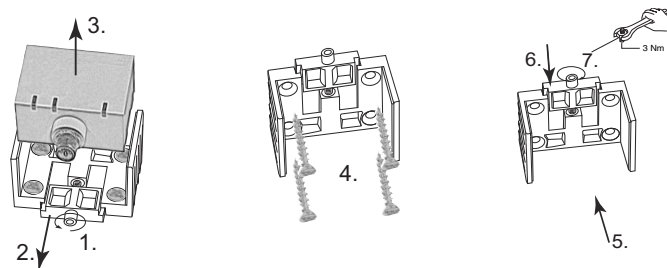

1. Loosen the central screw under the sensor connection.
 2. Slide back the clamping element until you are able to remove the sensor module from the housing.
 3. Remove the sensor module from the housing
 4. Position the housing at the required mounting location and secure using four countersunk screws. Make sure that the heads of the screws do not protrude.
 5. Place the sensor module in the housing.
 6. Slide the clamping element flush into the housing. Check that the sensor element is seated correctly.
 7. Finally tighten the central screw.
- The sensor is now mounted correctly.

Additional Information

LED display

Displays dependent on the operating state	LED green: Power	LED yellow out 1	LED yellow out 2
Teach-in of switching points (output S1):	off	flashes	off
Teach-in of switching points (output S2):	off	off	flashes
Activate teach-in mode for analog limits:	off	flashes	flashes
Teach-in of analog limits	off	flashes	off
Normal operation	on	switchings tate	switchings tate
Reset to factory settings: 2 s ... 10 s	off	flashes	flashes
> 10 s ... end of reset process Followed by normal operation	flashes	off	off
Undervoltage	flashes	off	off

Release date: 2020-04-24 Date of issue: 2020-06-03 Filename: 209308_eng.pdf

Axis definition

The definition of the X-axis is shown on the sensor housing by means of an imprinted and labeled double arrow. The figure shows the clockwise direction of rotation.

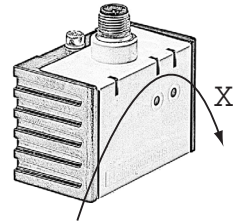
**Teach-in of switching points (output S1)**

1. Press key T1 > 2 s (see LED display)
2. Move sensor to switching position 1
3. Press key T1 briefly. LED "out 1" lights for 1.5 s as confirmation. Switching point 1 has been taught
4. Move sensor to switching position 2
5. Press key T1 briefly. LED "out 1" lights for 1.5 s as confirmation. Switching point 2 has been taught
6. Sensor returns to normal operation (see LED display)



The NC (active output state) is always defined in the range from the 1st configured position to 2nd configured position.

As an example :

Case #1: configure position #1 at +45degree, configure position #2 at +90 degree; NC is from +45 ' +90 in the CW direction

Case #2: configure position #1 at +90degree ; configure position #2 at +45 degree; NC is from +90 ' +45 in the CW direction

Teach-in of switching points (output S2)

Similar to the process for "Teach-in of switching points (output S1)", but with key T2 instead of key T1.

Teach-in of analog limits

1. Activate the teach-in mode for the analog limits by simultaneously pressing keys T1 and T2 until the green LED is extinguished and the two yellow LEDs flash. Then release the keys.
2. Press key T1 > for 2 s (see LED display)
3. Move the sensor into the position of minimum evaluation limit
4. Press key T1 briefly. LED "out 1" lights for 1.5 s as confirmation. The minimum evaluation limit has been taught. In this position the analog output will provide its minimum output value.
5. Move the sensor into the position of maximum evaluation limit
6. Press key T1 briefly. LED "out 1" lights for 1.5 s as confirmation. The maximum evaluation limit has been taught. In this position the analog output will provide its maximum output value.
7. Sensor returns to normal operation (see LED display)



If the sensor inclination exceeds one of the analog limits, the last value of the analog output is retained.

Resetting the sensor to factory settings

1. Press keys T1 and T2 > 10 s (see LED display)
2. The sensor has been reset when the green LED "Power" lights again after approx. 10 s.

Undervoltage detection

If the supply voltage falls below a value of approx. 7 V, all outputs and yellow LEDs are deactivated. The green "power" LED flashes rapidly. If the supply voltage falls below a value of approx. 8 V, the sensor continues with normal operation.

Technical Features

EMC Properties

Interference immunity in accordance with

DIN ISO 11452-2: 100 V/m

Frequency band 20 MHz up to 2 GHz

Mains-borne interference in accordance with ISO 7637-2:

Inclination sensor

INX360D-F99-I2E2-7M

Pulse	1	2	2	3	3	4
		a	b	a	b	
Severity level	I	I	I	I	I	I
	I	I	I	I	I	I
	I	I	I	I	I	I
Failure criterion	C	A	C	A	A	C
EN 61000-4-2:	CD: 8 kV		AD: 15 kV			
	/					
Severity level	IV		IV			
EN 61000-4-3:	30 V/m (80...2500 MHz)					
Severity level	IV					
EN 61000-4-4:	2 kV					
Severity level	III					
EN 61000-4-6:	10 V (0.01...80 MHz)					
Severity level	III					
EN 55011:	Klasse A					

Release date: 2020-04-24 Date of issue: 2020-06-03 Filename: 209308_eng.pdf