

## Inductive positioning system

### PMI14V-F166-U-1M-V15-Y215628

- Analog output 0 ... 10 V
- Measuring range 0 ... 14 mm
- Scalable measurement range programmable via cable



## Dimensions

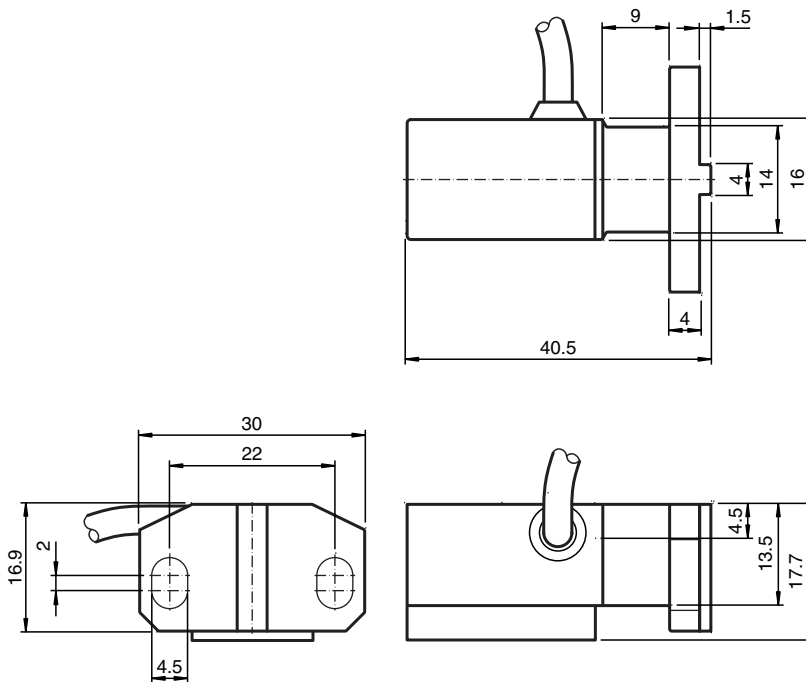

## Technical Data

### General specifications

Switching element function	Analog voltage output
Object distance	0.5 ... 2 mm
Measurement range	0 ... 14 mm

### Nominal ratings

Operating voltage	$U_B$	18 ... 30 V
Reverse polarity protection		reverse polarity protected
Linearity error		$\pm 0.3$ mm
Repeat accuracy	R	$\pm 0.05$ mm
Resolution		33 $\mu$ m

Release date: 2023-10-16 Date of issue: 2023-10-16 Filename: 215628\_eng.pdf

## Technical Data

Temperature drift		$\pm 0.4$ mm
No-load supply current	$I_0$	$\leq 20$ mA
<b>Analog output</b>		
Output type		1 voltage output: 0 ... 10 V
Load resistor		$\geq 1000 \Omega$
Short-circuit protection		pulsing
<b>Compliance with standards and directives</b>		
Standard conformity		
Standards		EN 60947-5-2:2007 IEC 60947-5-2:2007
<b>Ambient conditions</b>		
Ambient temperature		-10 ... 70 °C (14 ... 158 °F)
<b>Mechanical specifications</b>		
Connection type		
Material		
Housing		Zinc diecast, nickel-plated cover , PBT
Target		mild steel, e. g. 1.0037, SR235JR (formerly St37-2)
Connector		
Threading		M12 x 1
Tightening torque		0.6 Nm
Number of pins		5
Cable		
Cable diameter		4.8 mm $\pm$ 0.2 mm
Bending radius		> 10 x cable diameter
Material		PUR
Color		black
Number of cores		5
Core cross section		0.25 mm <sup>2</sup>
Length	L	1 m
Mass		74 g

## Connection

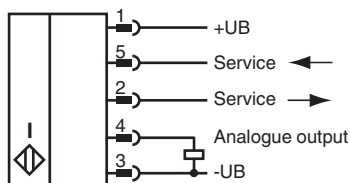

## Connection Assignment

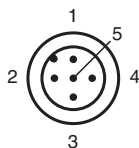

## Connection Assignment

Wire colors in accordance with EN 60947-5-2



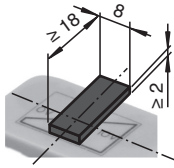

1	BN	(brown)
2	WH	(white)
3	BU	(blue)
4	BK	(black)
5	GY	(gray)

## Additional Information

dimensions for the target object:



## Accessories

	<b>BT-F90-W</b>	Damping element for sensors of type F90, F112, and F166; side hole
	<b>BT-F90-G</b>	Damping element for sensors of type F90, F112, and F166; front hole
	<b>MH V1-SCREWDRIVER</b>	Torque screwdriver (0.6 Nm)
	<b>MH V1-BIT M12</b>	plug-in cap M12