



Conductive Switch Amplifier

KFD2-ER-2.W.LB

- 2-channel signal conditioner
- 24 V DC supply (Power Rail)
- Level sensing input
- Adjustable range 1 k Ω ... 150 k Ω
- Relay contact output
- Adjustable time delay up to 10 s
- Minimum/maximum control
- Line fault detection (LFD)



Function

This signal conditioner provides the AC measuring voltage for the level sensing electrodes. Once the measured medium reaches the electrodes, the unit reacts by energizing a form C changeover relay contact. The module is voltage and temperature stabilized and guarantees a defined switching characteristic. It can be used for on/off control or minimum/maximum control. A signal delay feature is available and is adjustable between 0.5 s and 10 s. This module can also monitor the field circuit for lead breakage (LB). LB is indicated by a red LED. This function can be deactivated with DIP switches.

Application

The device is equipped with lead breakage detection (current free relay in event of failure). For this purpose, the enclosed 430 k Ω resistance must be switched between the maximum and reference electrode. This function can be deactivated by DIP switches.

Connection

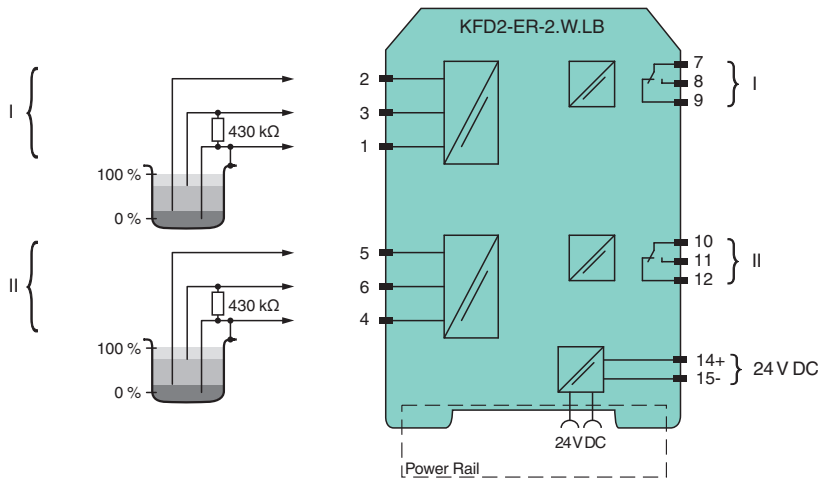

Technical Data

General specifications			
Signal type	Digital Input		
Supply			
Connection	Power Rail or terminals 14+, 15-		
Rated voltage	U_r	20 ... 30 V DC	
Rated current	I_r	30 ... 40 mA	
Input			

Release date: 2023-06-05 Date of issue: 2023-06-05 Filename: 217734_eng.pdf

Technical Data





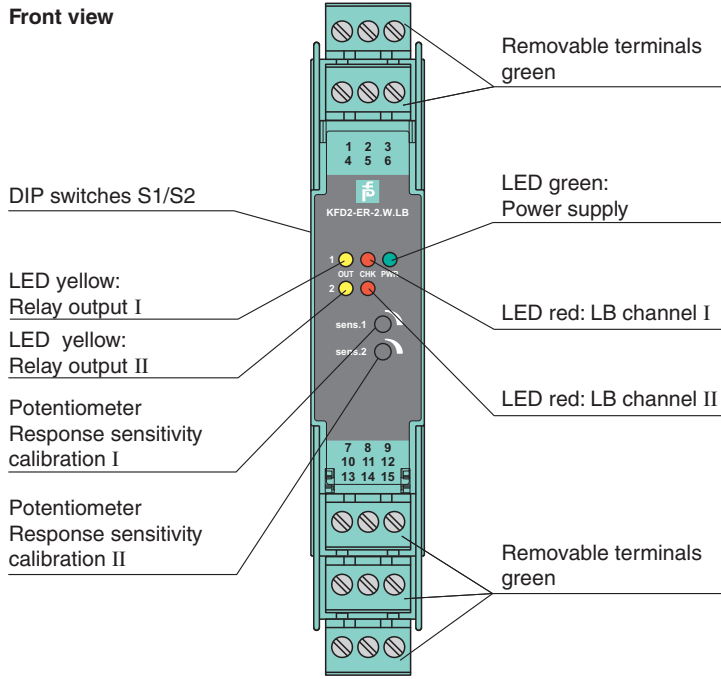

Connection side	field side
Connection	terminals 1, 4 (mass), 2, 5 (min), 3, 6 (max)
Control input	min./max. control system: terminals 1, 2, 3; 4, 5, 6 on/off control system: terminals 1, 3; 4, 6
Response sensitivity	1 ... 150 k Ω , adjustable via potentiometer
Output	
Connection side	control side
Connection	terminals 7, 8, 9; 10, 11, 12
Switching power	max. 192 W , 2000 VA
Output	relay
Contact loading	253 V AC/2 A/cos ϕ > 0.7; 40 V DC/2 A resistive load
Time constant for signal damping	0.5 s, 2 s, 5 s, 10 s
Galvanic isolation	
Input/Output	basic insulation according to EN 50178, rated insulation voltage 253 V _{eff}
Input/power supply	basic insulation according to EN 50178, rated insulation voltage 253 V _{eff}
Output/power supply	basic insulation according to EN 50178, rated insulation voltage 253 V _{eff}
Indicators/settings	
Display elements	LEDs
Control elements	DIP switch potentiometer
Configuration	via DIP switches via potentiometer
Labeling	space for labeling at the front
Directive conformity	
Electromagnetic compatibility	
Directive 2004/108/EC	EN 61326-1:2006
Low voltage	
Directive 2006/95/EC	EN 50178:1997
Conformity	
Insulation coordination	EN 50178:1997
Galvanic isolation	EN 50178:1997
Electromagnetic compatibility	NE 21:2006
Degree of protection	IEC 60529:2001
Ambient conditions	
Ambient temperature	-20 ... 60 °C (-4 ... 140 °F) extended ambient temperature range up to 70 °C (158 °F), refer to manual for necessary mounting conditions
Mechanical specifications	
Degree of protection	IP20
Connection	screw terminals , max. 2.5 mm ²
Mass	approx. 150 g
Dimensions	20 x 119 x 115 mm (0.8 x 4.7 x 4.5 inch) (W x H x D) , housing type B2
Mounting	on 35 mm DIN mounting rail acc. to EN 60715:2001
General information	
Supplementary information	Observe the certificates, declarations of conformity, instruction manuals, and manuals where applicable. For information see www.pepperl-fuchs.com .

Assembly



Front view



Matching System Components

	KFD2-EB2	Power Feed Module
	UPR-03	Universal Power Rail with end caps and cover, 3 conductors, length: 2 m
	UPR-03-M	Universal Power Rail with end caps and cover, 3 conductors, length: 1,6 m
	UPR-03-S	Universal Power Rail with end caps and cover, 3 conductors, length: 0.8 m
	K-DUCT-GY	Profile rail, wiring comb field side, gray
	K-DUCT-GY-UPR-03	Profile rail with UPR-03-* insert, 3 conductors, wiring comb field side, gray

Accessories

	KF-ST-5GN	Terminal block for KF modules, 3-pin screw terminal, green
	KF-CP	Red coding pins, packaging unit: 20 x 6

Release date: 2023-06-05 Date of issue: 2023-06-05 Filename: 217734_eng.pdf

Configuration

DIP switches function on side of device

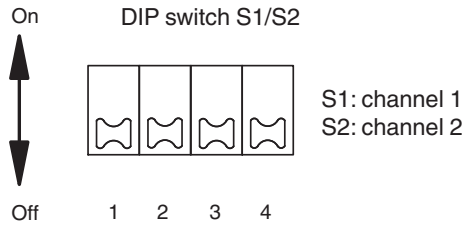

Switches	Position	Function
1	Off	open circuit current
	On	closed circuit current
2	Off	LB deactivated
	On	LB activated

Switch 3	Switch 4	Time constant for signal damping
Off	Off	0.5 s
Off	On	2 s
On	Off	5 s
On	On	10 s

- Open circuit current principle: In open circuit current principle the relay becomes active when the limit is reached.
- Closed circuit current principle: In closed circuit current principle, the relay is activated when power is applied. The relay is deactivated when the limit is reached.

Release date: 2023-06-05 Date of issue: 2023-06-05 Filename: 217734_eng.pdf