

Radar sensor RaDec-M Silver

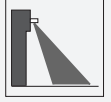

- Standard radar motion sensor with basic functionality
- Reliable detection of people and vehicles
- Simplest adjustment of the sensing range
- Wide range of sensitivity adjustment
- Wall and ceiling mountable

Standard radar motion sensor with basic functionality, detection range 2 m x 4.5 m, max. installation height 4 m, silver housing, relay contact output, cable connection



Function

Dimensions

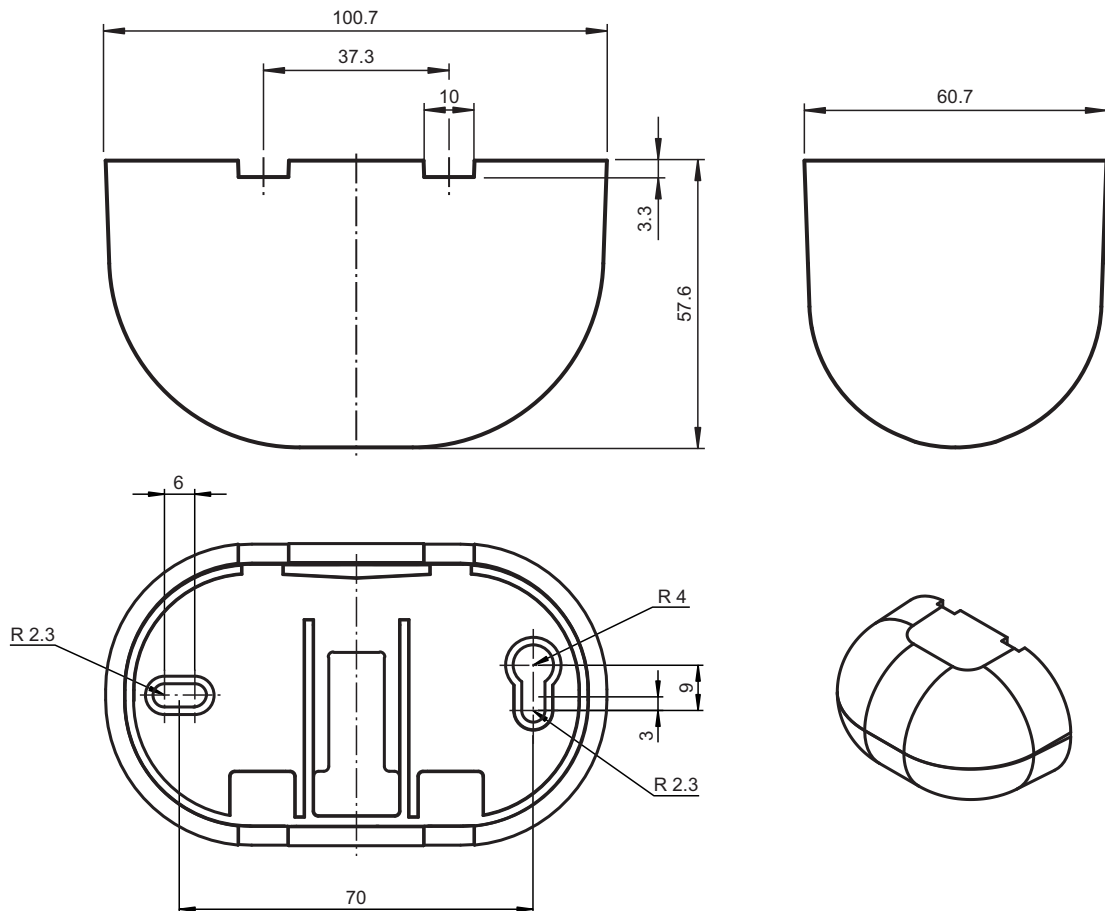

Release date: 2020-10-08 Date of issue: 2020-10-08 Filename: 220101_eng.pdf

Technical Data

General specifications	
Sensing range	broad: 2000x 4500 mm (DxW) at 2200 mm mounting height and 30° tilt angle narrow: 4500x 2000 mm (DxW) at 2200 mm mounting height and 30° tilt angle
Function principle	Microwave module
Detection speed	min. 0.1 m/s
Setting angle	0 ... 90 ° in 5 ° increments
Operating frequency	24.15 ... 24.25 GHz K-Band
Operating mode	Radar motion sensor
Transmitter radiated power (EIRP)	< 20 dBm
Functional safety related parameters	
MTTF _d	970 a
Mission Time (T _M)	20 a
Diagnostic Coverage (DC)	0 %
Indicators/operating means	
Function indicator	LED red
Control elements	potentiometer
Control elements	sensitivity adjustment
Electrical specifications	
Operating voltage	U _B 12 ... 36 V DC , 12 ... 28 V AC
No-load supply current	I ₀ ≤ 50 mA at 24 V DC
Power consumption	P ₀ ≤ 1.7 W
Output	
Switching type	NO/NC
Signal output	relay
Switching voltage	max. 48 V AC / 48 V DC
Switching current	max. 0.5 A AC / 1 A DC
Switching power	max. 24 W / 60 VA
De-energized delay	t _{off} 0.5 s
Approvals and certificates	
CE conformity	2014/53/EU This device can be used in all countries within the European Union. In other countries, all applicable national regulations must be observed.
EAC conformity	TR CU 020/2011
FCC approval	No - Use in North America is not permitted.
Ambient conditions	
Operating temperature	-20 ... 60 °C (-4 ... 140 °F)
Storage temperature	-30 ... 70 °C (-22 ... 158 °F)
Relative humidity	max. 90 % non-condensing
Mechanical specifications	
Mounting height	max. 4000 mm
Degree of protection	IP54
Connection	Connecting cable 2.5 m included with delivery
Material	
Housing	Polycarbonate (PC), silver painted
Mass	130 g
Dimensions	101 mm x 60 mm x 59 mm
Suitable series	
Series	RaDec

Connection Assignment

Option:

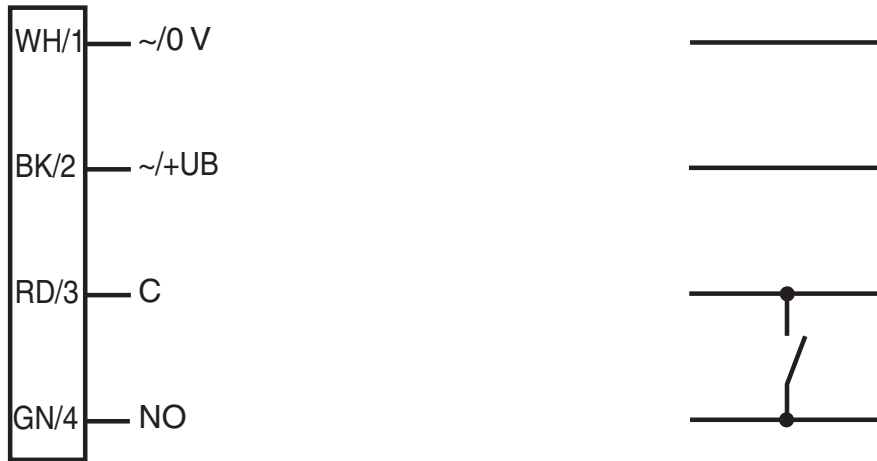

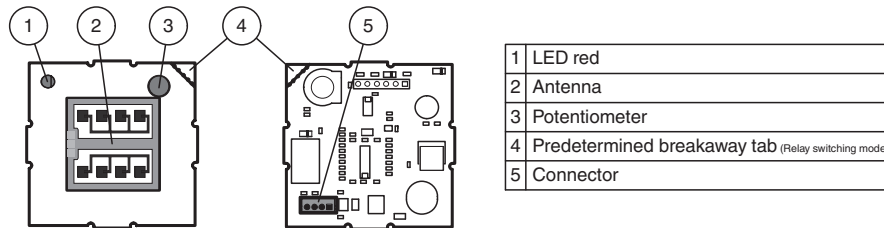

Assembly



Application



Accessories

	RaDec Weather Cap Silver	Weather hood for radar sensors series RaDec
	RMS/RaDec Ceiling Kit wh	Ceiling mount kit for radar sensors in the RMS and RaDec Series

Release date: 2020-10-08 Date of issue: 2020-10-08 Filename: 220101_eng.pdf

Commissioning

Sensing Range

A narrower or wider sensing area can be achieved with turning the plug-in antenna.

Wide:

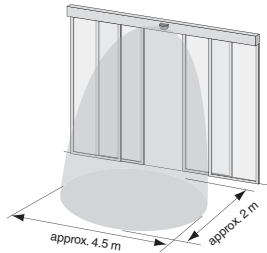

Mounting height 2200 mm / tilt angle 30°
Antenna position:

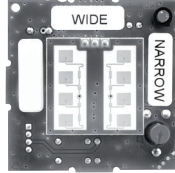

Narrow:

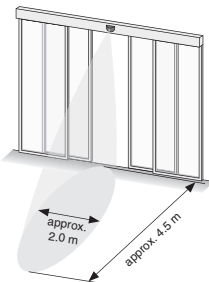

Mounting height 2200 mm / tilt angle 30°
Antenna position:

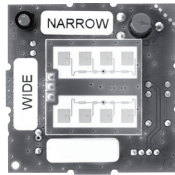

The detection field can be swivelled in 10 steps from 0° ... 90°.

Sensitivity Settings

The sensitivity potentiometer can be used to adjust the size of the detection field.

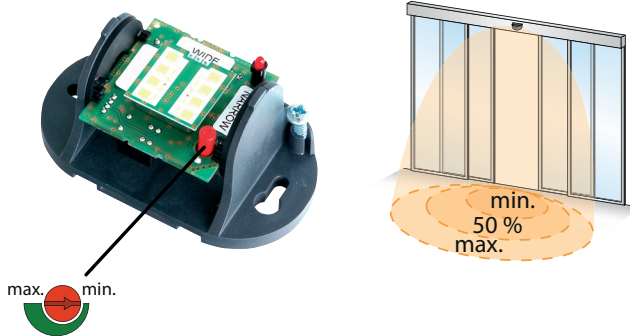

Accessories

Other suitable accessories can be found at www.pepperl-fuchs.com

Function Principle

Microwave sensors are microwave scanners that use the principle of the Doppler radar. The most important requirement for microwave detection is that the object to be detected is moving. Some applications include controlling automatic and industrial doors.

The microwave sensors emit microwaves of a defined frequency in order to detect people and large objects moving at speeds between 100 mm/sec and 5 m/sec. Stationary people or objects are not detected. Based on the latest 24 GHz technology with integrated microprocessor control, these sensors provide a high degree of reliability even in difficult operating conditions. The 24 GHz frequency, known as the 'K-band,' is reserved by CETECOM for this application area worldwide.

Application

- Opening impulse sensors for automatic doors and industrial doors
- Monitoring approach areas to elevators
- Motion sensors for people and objects

Release date: 2020-10-08 Date of issue: 2020-10-08 Filename: 220101_eng.pdf

Radar sensor

RaDec-M Silver

- Impulse sensors for escalators

Release date: 2020-10-08 Date of issue: 2020-10-08 Filename: 220101_eng.pdf