

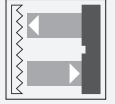

Retroreflective sensor

MLV41-55-IO/98/103



- Rugged series in corrosion-resistant metal housing
- IO-Link interface for service and process data
- Extremely high switching frequency
- Clear and functional display concept for the operating modes
- Resistant against noise: reliable operation under all conditions
- Aluminum housing with high quality Delta-Seal coated

Robust retroreflective sensor with polarization filter, compact housing design, IO-Link interface, 7 m detection range, red light, dark on, PNP output, M8 plug



Function

The unique and extremely popular design of the MLV41 series enables it to be mounted correctly in confined areas and offers all the functions that are normally only found on larger photoelectric sensors. The MLV41 series comes with a range of functions. For example, highly visible status LEDs on the front and back, resistance to ambient light, crosstalk protection and universally applicable output stages that permit every possible switching logic and polarity to be realized. The enhanced resistance to ambient light ensures reliable operation even where modern energy-saving lamps with electronic ballasts are in use. The same applies where multiple devices are present, i.e. the use of a number of sensors in the same vicinity causes no problems.

Dimensions

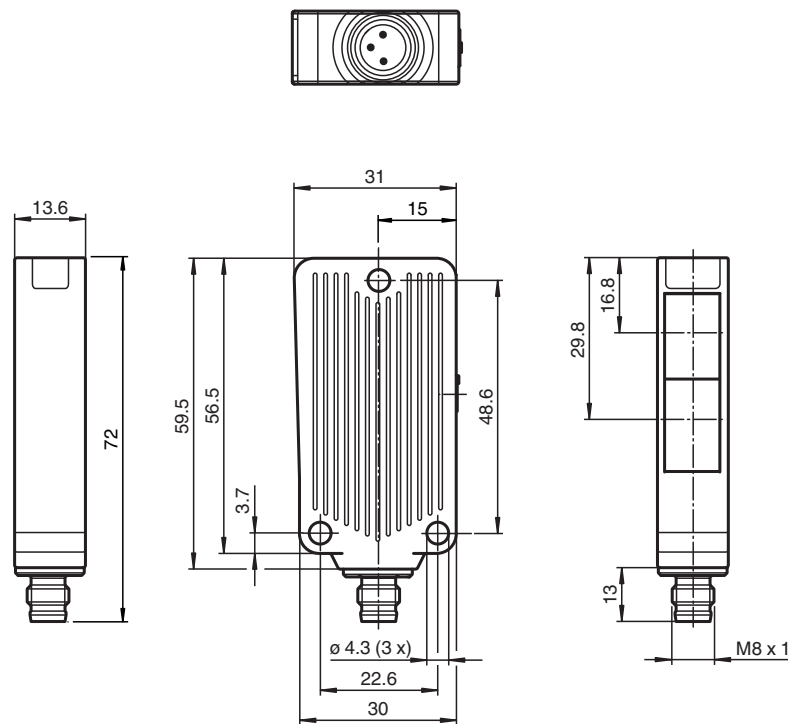

Technical Data

General specifications	
Effective detection range	0 ... 7 m
Reflector distance	0.1 ... 8 m
Threshold detection range	10 m
Reference target	H85-2 reflector
Light source	LED
Light type	modulated visible red light , 625 nm
Polarization filter	yes
Angle deviation	max. $\pm 1.5^\circ$
Diameter of the light spot	approx. 300 mm at detection range 8.5 m
Opening angle	1.5°
Optical face	frontal
Ambient light limit	20000 Lux
Functional safety related parameters	
MTTF _d	844 a
Mission Time (T _M)	20 a
Diagnostic Coverage (DC)	0 %
Indicators/operating means	
Operation indicator	LED green, statically lit Power on , Undervoltage indicator: Green LED, pulsing (approx. 0.8 Hz) , short-circuit : LED green flashing (approx. 4 Hz) , IO link communication: green LED goes out briefly (1 Hz)
Function indicator	LED yellow, lights up when light beam is free, flashes when falling short of the operating reserve

Release date: 2023-03-28 Date of issue: 2023-03-28 Filename: 221550_eng.pdf

Technical Data

Control elements		none
Electrical specifications		
Operating voltage	U_B	10 ... 30 V DC
Ripple		max. 10 %
No-load supply current	I_0	max. 30 mA
Interface		
Interface type		IO-Link
Protocol		IO-Link V1.0
Mode		COM2 (38.4 kBit/s)
Output		
Signal output		1 PNP output, short-circuit protected, reverse polarity protected, open collector
Switching voltage		max. 30 V DC
Switching current		max. 100 mA
Voltage drop	U_d	≤ 2.5 V DC
Switching frequency	f	1000 Hz
Response time		0.5 ms
Conformity		
Product standard		EN 60947-5-2
Approvals and certificates		
UL approval		cULus Listed 57M3 (Only in association with UL Class 2 power supply; Type 1 enclosure)
CCC approval		CCC approval / marking not required for products rated ≤ 36 V
Ambient conditions		
Ambient temperature		-40 ... 60 °C (-40 ... 140 °F)
Storage temperature		-40 ... 75 °C (-40 ... 167 °F)
Mechanical specifications		
Housing width		31 mm
Housing height		56.5 mm
Housing depth		13.6 mm
Degree of protection		IP67
Connection		M8 x 1 connector, 3-pin
Material		
Housing		Aluminum , Delta-Seal coated
Optical face		glass pane
Connector		metal
Mass		50 g

Connection Assignment

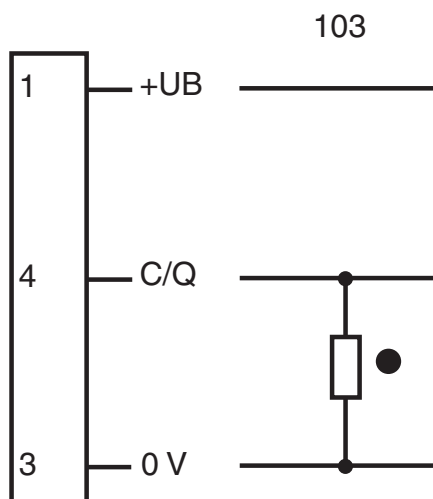

- = Light on
- = Dark on

Connection Assignment



Wire colors in accordance with EN 60947-5-2

1	BN	(brown)
3	BU	(blue)
4	BK	(black)

Assembly

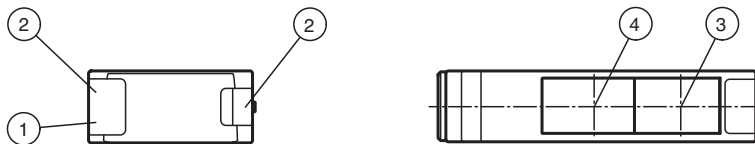

1	Operating display green	3	Optical axis transmitter
2	Function display yellow	4	Optical axis receiver

Characteristic Curve

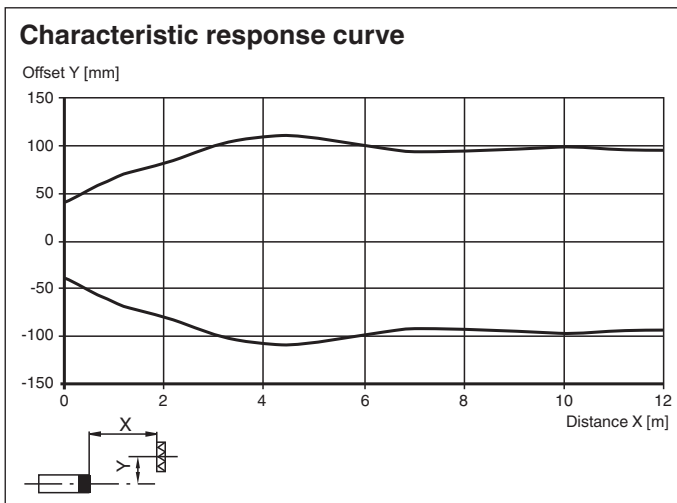





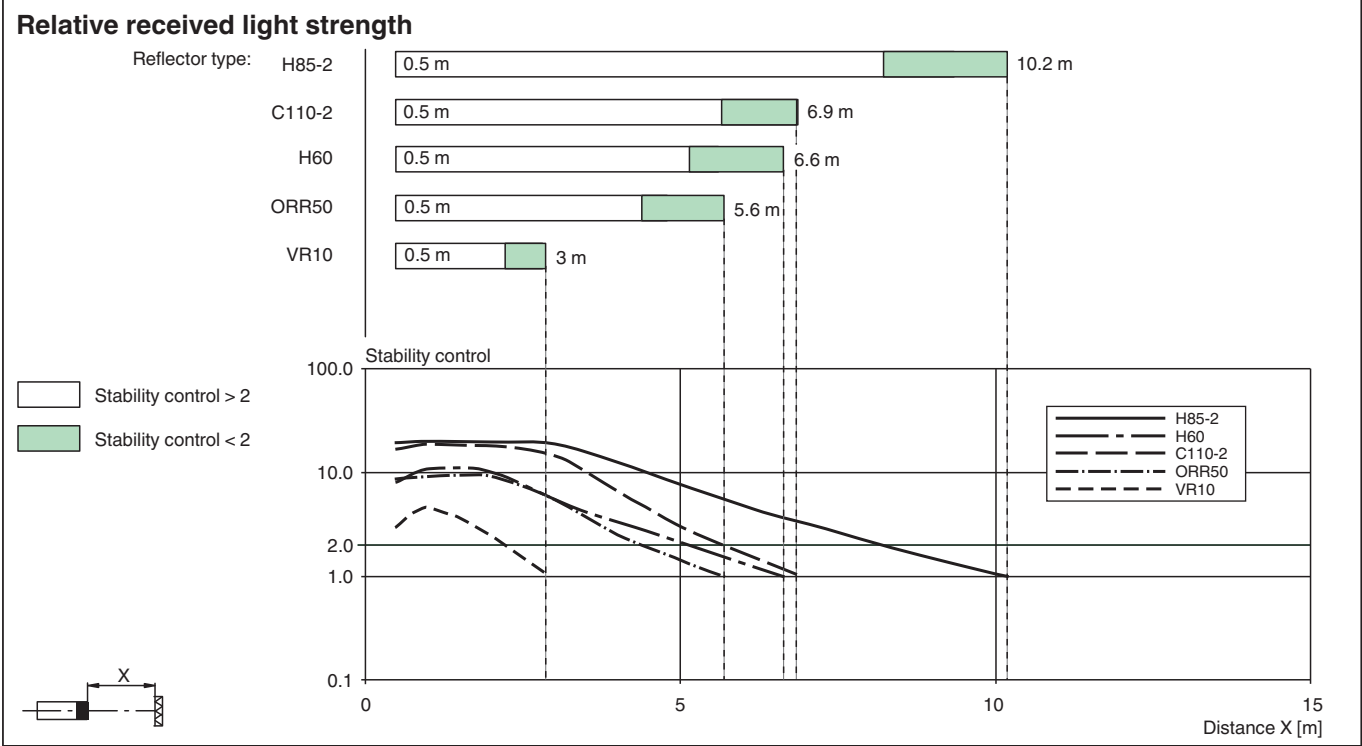





Release date: 2023-03-28 Date of issue: 2023-03-28 Filename: 221550_eng.pdf

Characteristic Curve









Accessories

	OMH-09	Mounting bracket for Sensors series MLV41 for M12 rod mounting
	OMH-40	Mounting bracket
	PACTware 4.1	FDT Framework
	REF-H85-2	Reflector, rectangular 84.5 mm x 84.5 mm, mounting holes
	REF-H50	Reflector, rectangular 51 mm x 61 mm, mounting holes, fixing strap
	REF-VR10	Reflector, rectangular 60 mm x 19 mm, mounting holes
	ORR50G	Reflector, rectangular 50.9 mm x 60.9 mm, mounting holes, fixing strap and polarization filter
	OFR-100/100	Reflective tape 100 mm x 100 mm
	ICE2-8IOL-G65L-V1D	EtherNet/IP IO-Link master with 8 inputs/outputs
	ICE3-8IOL-G65L-V1D	PROFINET IO IO-Link master with 8 inputs/outputs
	ICE1-8IOL-G30L-V1D	Ethernet IO-Link module with 8 inputs/outputs

Release date: 2023-03-28 Date of issue: 2023-03-28 Filename: 221550_eng.pdf

Accessories

	ICE1-8IOL-G60L-V1D	Ethernet IO-Link module with 8 inputs/outputs
	ICE2-8IOL-K45P-RJ45	EtherNet/IP IO-Link master with 8 inputs/outputs, DIN rail, push-in connectors
	ICE2-8IOL-K45S-RJ45	EtherNet/IP IO-Link master with 8 inputs/outputs, DIN rail, screw terminal
	ICE3-8IOL-K45P-RJ45	PROFINET IO IO-Link master with 8 inputs/outputs, DIN rail, push-in terminals
	ICE3-8IOL-K45S-RJ45	PROFINET IO IO-Link master with 8 inputs/outputs, DIN rail, screw terminal
	IO-Link-Master02-USB	IO-Link master, supply via USB port or separate power supply, LED indicators, M12 plug for sensor connection

IO link function

The IO link operating mode is indicated by the green LED indicator with a short interruption ($f = 1 \text{ Hz}$). IO link communication simultaneously provides process data (measurement data from the sensor) and access to requirement data.

The requirement data contains the following information:

Identification:

- Manufacturer information
- Product ID
- User-specific ID

Device parameters:

- Teach-in parameters
- Operating parameters
- Configuration parameters
- Device commands

Diagnostic messages and warnings