



Diffuse mode sensor

WTS10-12/21/105



- Specifically for quality checks on welding caps
- Upper and lower welding caps checked simultaneously
- High position and angle tolerance insensitivity of the welding cap
- Stability alarm indication
- Scratch resistant mineral glass lens

Diffuse mode sensor



Function

The welding tip sensor WTS10 series is a contrast evaluation sensor with a large and homogeneous light spot fitted to check the quality of the welding cap's face after milling of the welding tip and which is widely used for industrial welding robots. After the milling process of the welding cap, both tips of the welding gun are inspected and defects such as inclusions, faulty milling or burrs are detected.

Simultaneous control of the quality of both welding tip caps with one sensor is possible by providing two optical outputs on either side of the sensor housing.

The WTS10 features an extended detection area of 11 mm diameter, an uniform lightspot over the full sensing range due to coaxial optics beam path, a new display concept, high switching accuracy, a homogenous light spot and improved position and tilting angle tolerance.

Dimensions

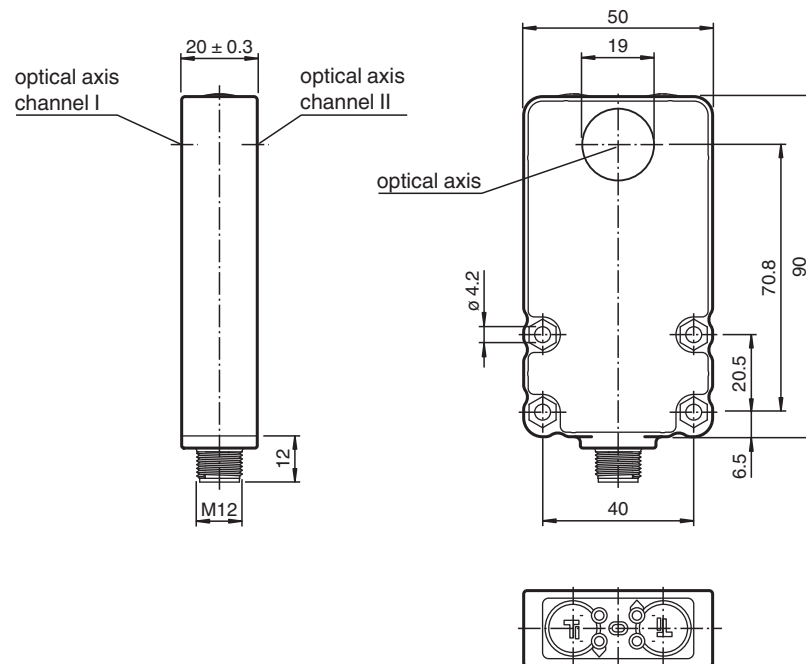

Technical Data

General specifications	
Detection range	2 ... 12 mm
Reference target	Copper welding-electrode Diameter: 16 mm , Front end: 6 mm
Light source	LED
Light type	modulated visible red light , 640 nm
Ambient light limit	continuous light 40000 Lux , Modulated light 5000 Lux
Tilting angle	± 1.5 °
Position tolerance	± 2 mm
Indicators/operating means	
Operation indicator	LED green: Power on
Function indicator	LED yellow: switching state LED red: Stability alarm indicator
Teach-In indicator	LED, green/yellow flashing (approx. 4 Hz) Teach Error:LED green/yellow non equiphase flashing; 8.0 Hz
Control elements	Teach-In key
Electrical specifications	
Operating voltage	U_B 10 ... 30 V DC
No-load supply current	I_0 ≤ 70 mA
Output	
Switching type	light-on
Signal output	2 switch outputs NPN, NO short-circuit protected reverse polarity protected
Switching current	max. 100 mA
Switching frequency	f 100 Hz

Release date: 2023-04-04 Date of issue: 2023-04-04 Filename: 223093_eng.pdf

Technical Data

Response time	5 ms
Conformity	
Product standard	EN 60947-5-2
Compliance with standards and directives	
Standard conformity	
Shock and impact resistance	IEC / EN 60068. half-sine, 50 g in each X, Y and Z directions
Vibration resistance	IEC / EN 60068-2-6. Sinus. 10 -150 Hz, 5 g in each X, Y and Z directions
Approvals and certificates	
Protection class	II, rated voltage ≤ 250 V AC with pollution degree 1-2 according to IEC 60664-1
UL approval	cULus Listed
CCC approval	CCC approval / marking not required for products rated ≤36 V
Ambient conditions	
Ambient temperature	0 ... 50 °C (32 ... 122 °F) The switching accuracy will remain, if the temperature after Teach-In does not varies more than ±7 °C
Storage temperature	-20 ... 70 °C (-4 ... 158 °F)
Mechanical specifications	
Degree of protection	IP67
Connection	5-pin, M12 x 1 connector
Material	
Housing	PC + ABS
Optical face	Scratch resistant mineral glass lens
Mass	80 g

Connection Assignment

Option:

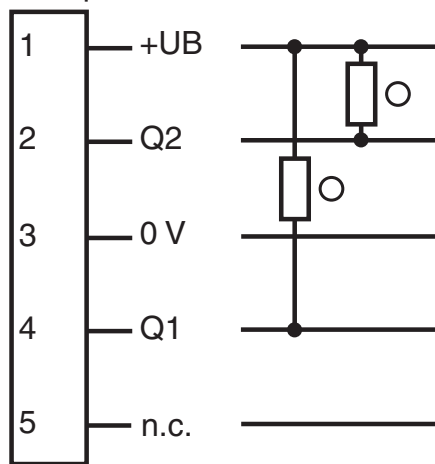

○ = Light on
● = Dark on

Connection Assignment

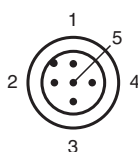

Connection Assignment

Wire colors in accordance with EN 60947-5-2

1	BN	(brown)
2	WH	(white)
3	BU	(blue)
4	BK	(black)
5	GY	(gray)

Assembly

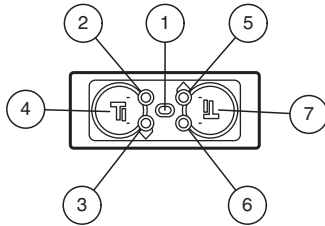

1	LED Power On	green
2	LED channel I	red
3	LED channel I	yellow
4	Teach-In channel I	
5	LED channel II	yellow
6	LED channel II	red
7	Teach-In channel II	

Characteristic Curve

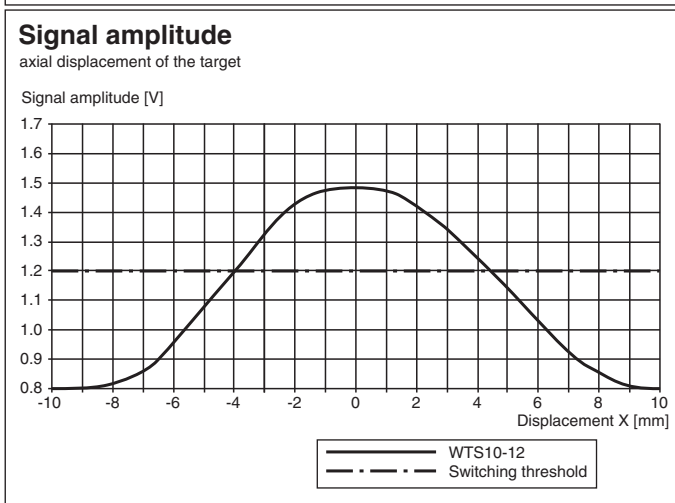
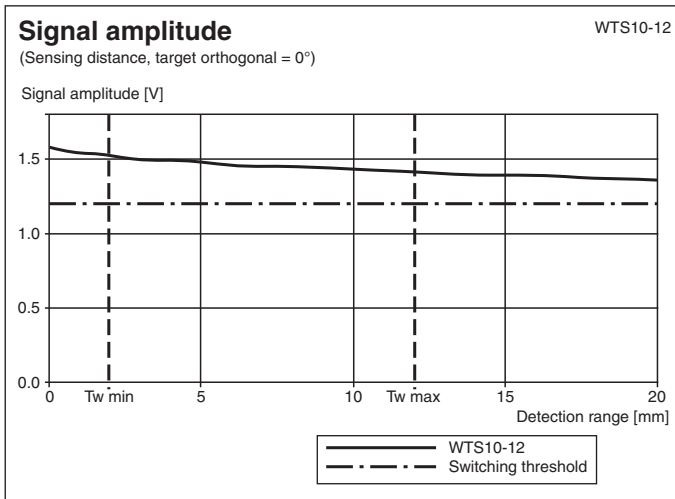

Release date: 2023-04-04 Date of issue: 2023-04-04 Filename: 223093_eng.pdf

Characteristic Curve

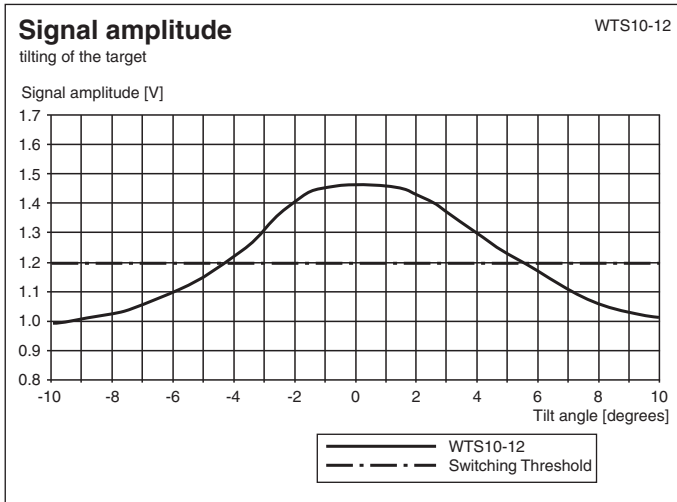





Teach-In

1. Position the reference welding cap in front of the optical system of the desired sensor channel (channel I or channel II).
2. Press and hold the corresponding teach-in button. The sensor confirms the keystroke by the green signal indicator being extinguished briefly (200 ms). After 2 s the sensor switches to teach-in mode: both switching outputs are deactivated. The sensor is taught the properly milled welding cap as a reference sample for the selected sensor channel.
3. When the green signal indicator and the yellow signal indicator that belongs to the selected sensor channel flash simultaneously, release the teach-in button. Teach-in is completed. The green signal indicator and the yellow signal indicator that belongs to the selected sensor channel flash alternately for 2 s.

Teach-in successful: The taught reference welding cap is permanently saved. The sensor switches back to switching mode.

Teach-in unsuccessful: The green signal indicator and the yellow signal indicator that belongs to the selected sensor channel flash quickly (approx. 8 Hz) and alternately for 5 s. The sensor discards the taught values. After 5 s the sensor switches to switching mode and works with the last valid values. For signal levels below the fixed switching threshold, the teach-in mode can't be entered. A teach-in error is indicated.

Accessories

	OMH-WTS10-01	Mounting bracket for sensors of WTS10 series
	V15-G-2M-PVC	Female cordset single-ended M12 straight A-coded, 5-pin, PVC cable grey
	V15-G-2M-PUR	Female cordset single-ended M12 straight A-coded, 5-pin, PUR cable grey
	V15-W-5M-PVC	Female cordset single-ended M12 angled A-coded, 5-pin, PVC cable grey